

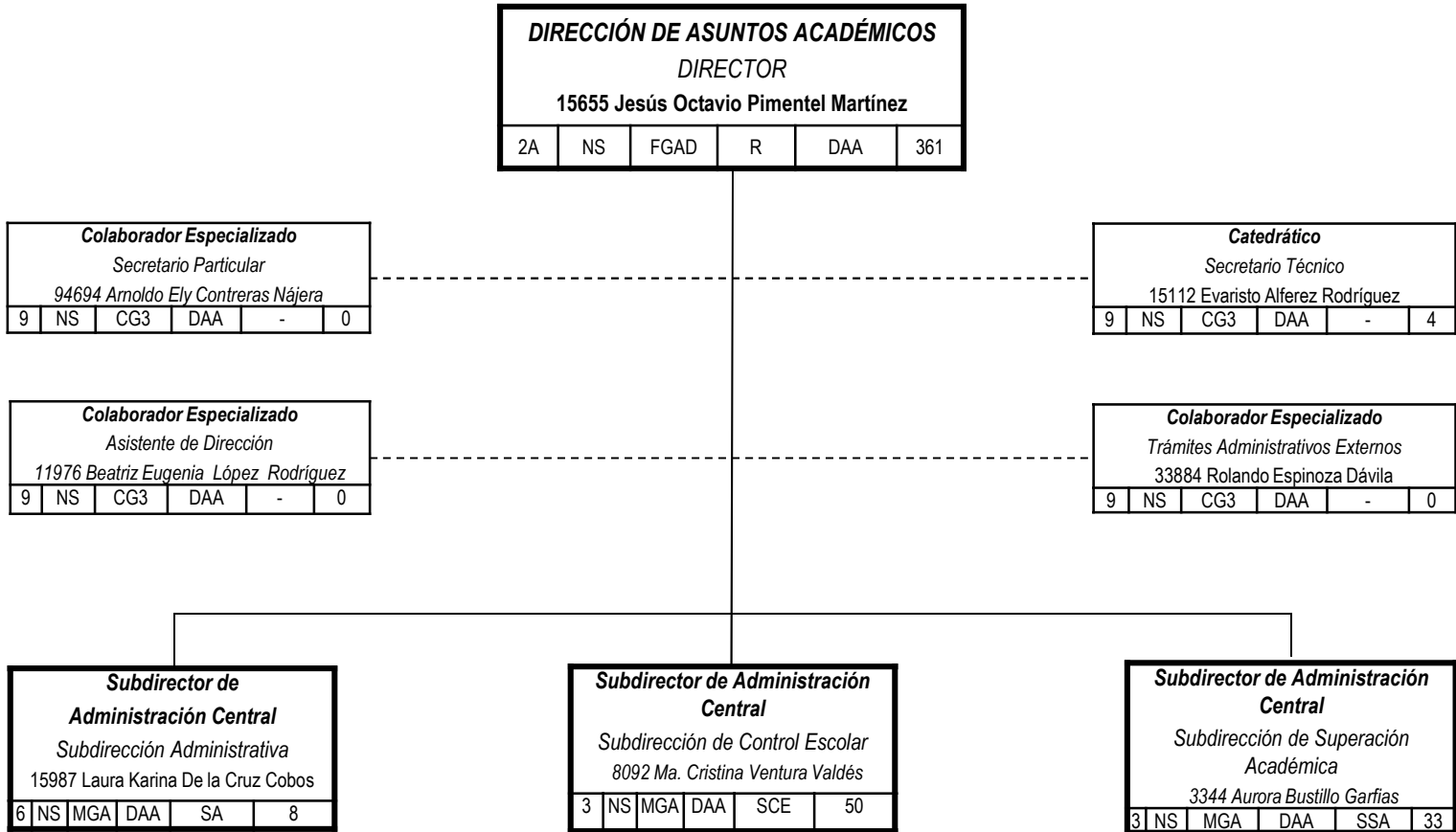

Unidad: **ADMINISTRACIÓN CENTRAL** Dependencia: **DIRECCIÓN DE ASUNTOS ACADÉMICOS**





Unidad: **ADMINISTRACIÓN CENTRAL** Dependencia: **DIRECCIÓN DE ASUNTOS ACADÉMICOS**

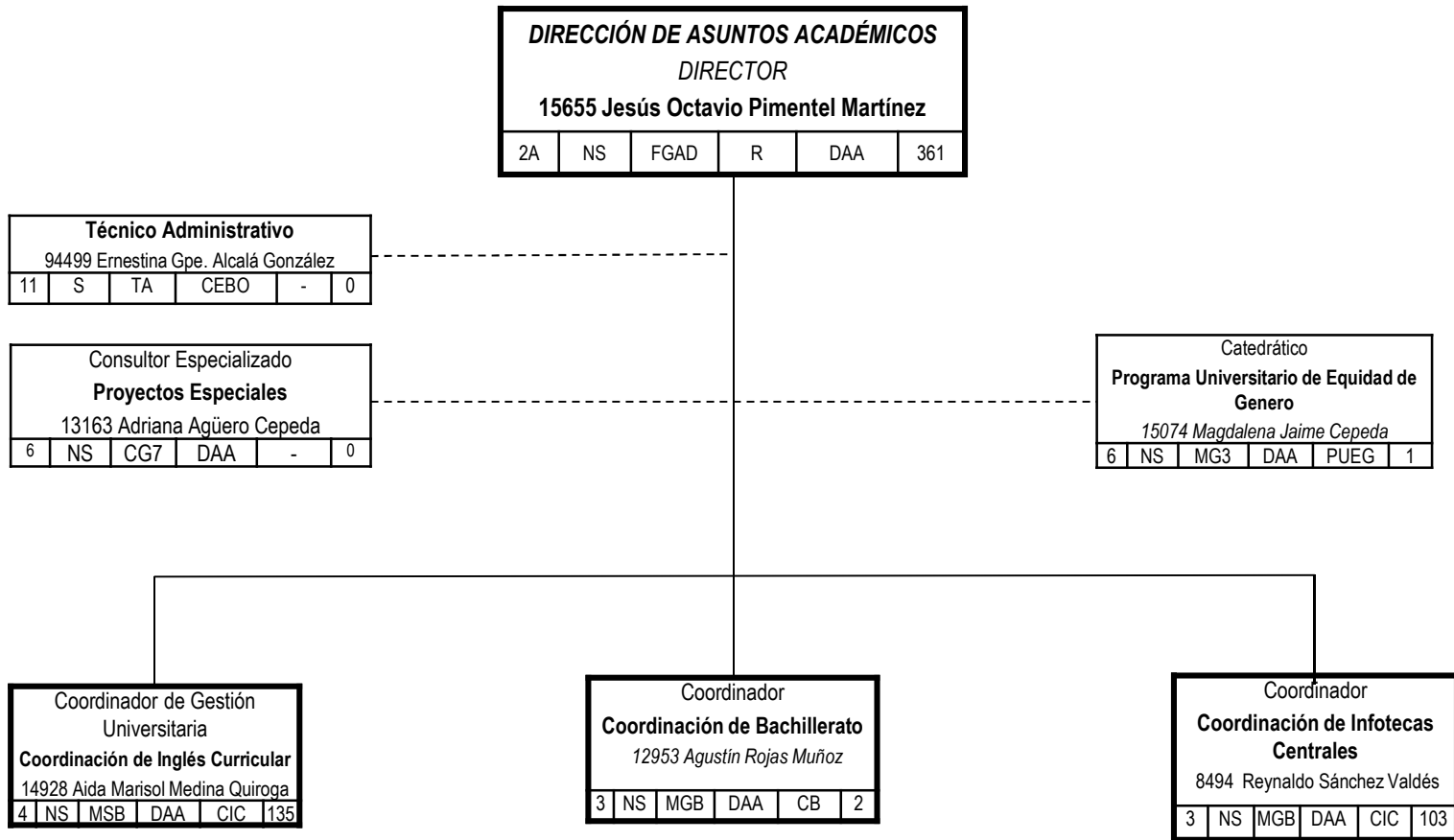



Unidad: **ADMINISTRACIÓN CENTRAL** Dependencia: **DIRECCIÓN DE ASUNTOS ACADÉMICOS**

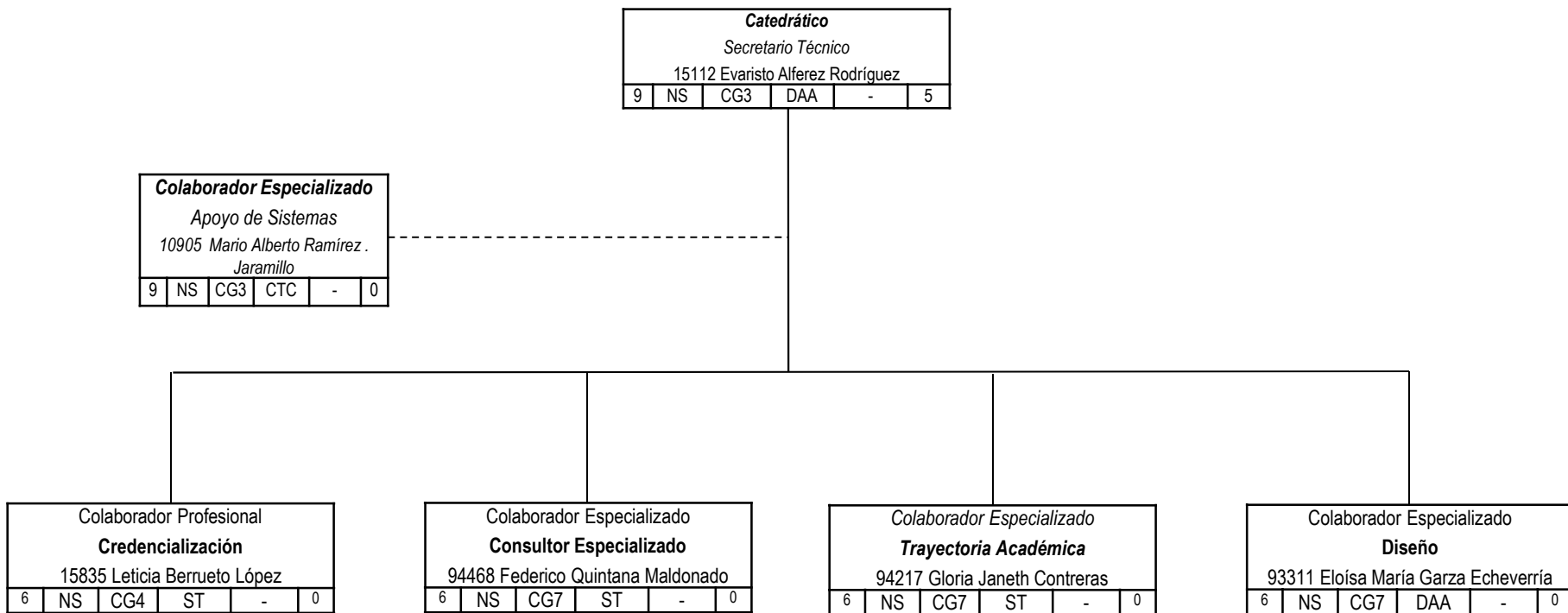



Unidad: **ADMINISTRACIÓN CENTRAL** Dependencia: **DIRECCIÓN DE ASUNTOS ACADÉMICOS**

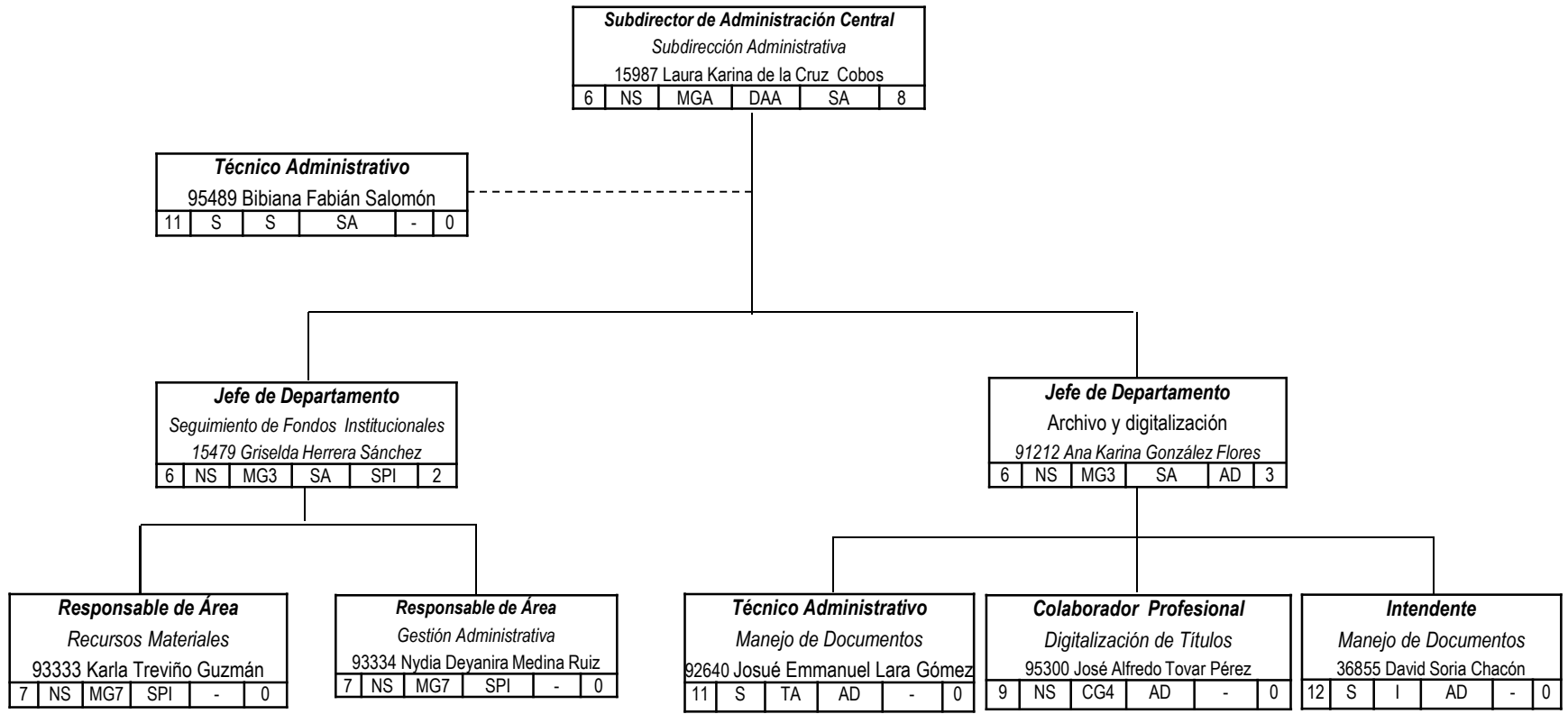



Unidad: **ADMINISTRACIÓN CENTRAL** Dependencia: **DIRECCIÓN DE ASUNTOS ACADÉMICOS**

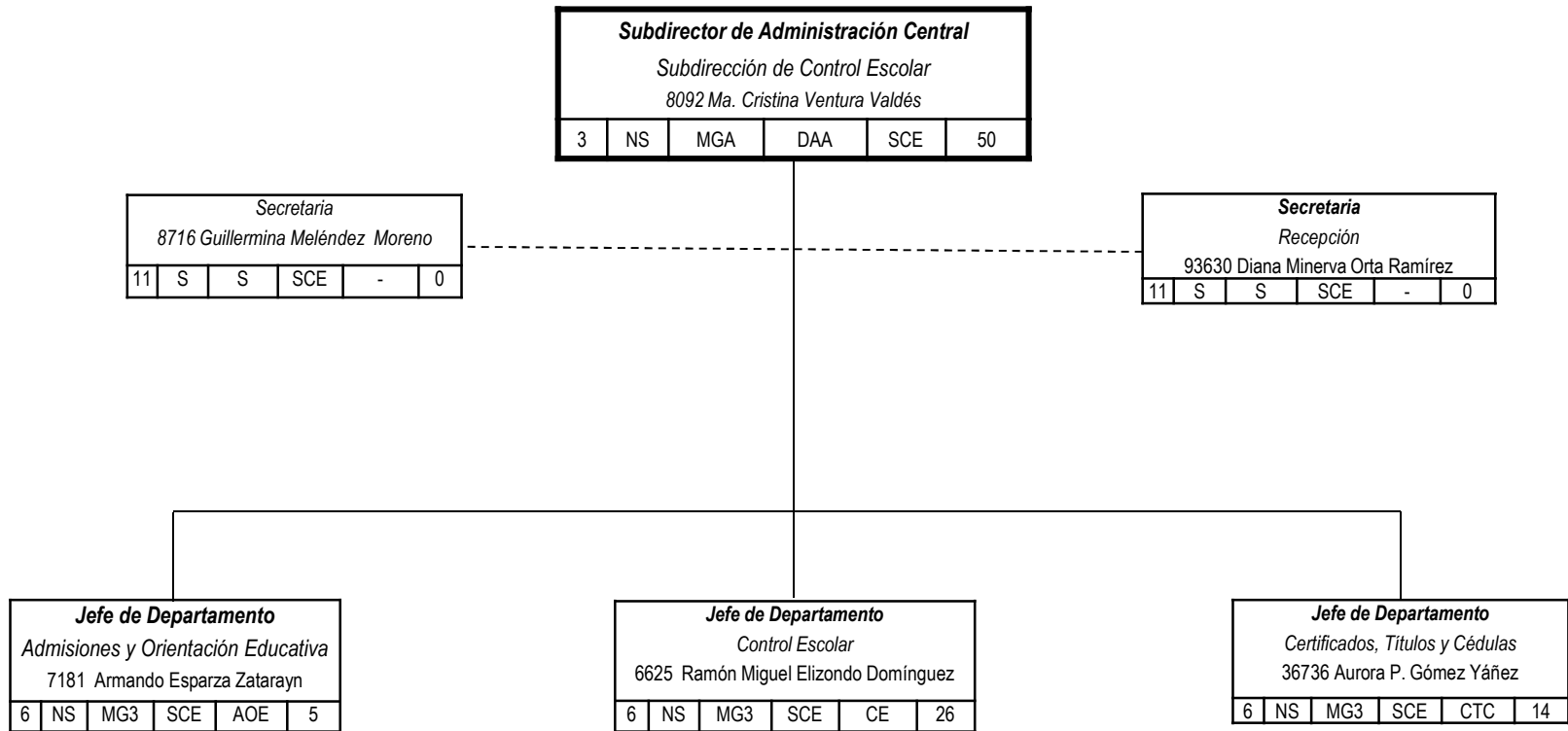



Unidad: **ADMINISTRACIÓN CENTRAL** Dependencia: **DIRECCIÓN DE ASUNTOS ACADÉMICOS**

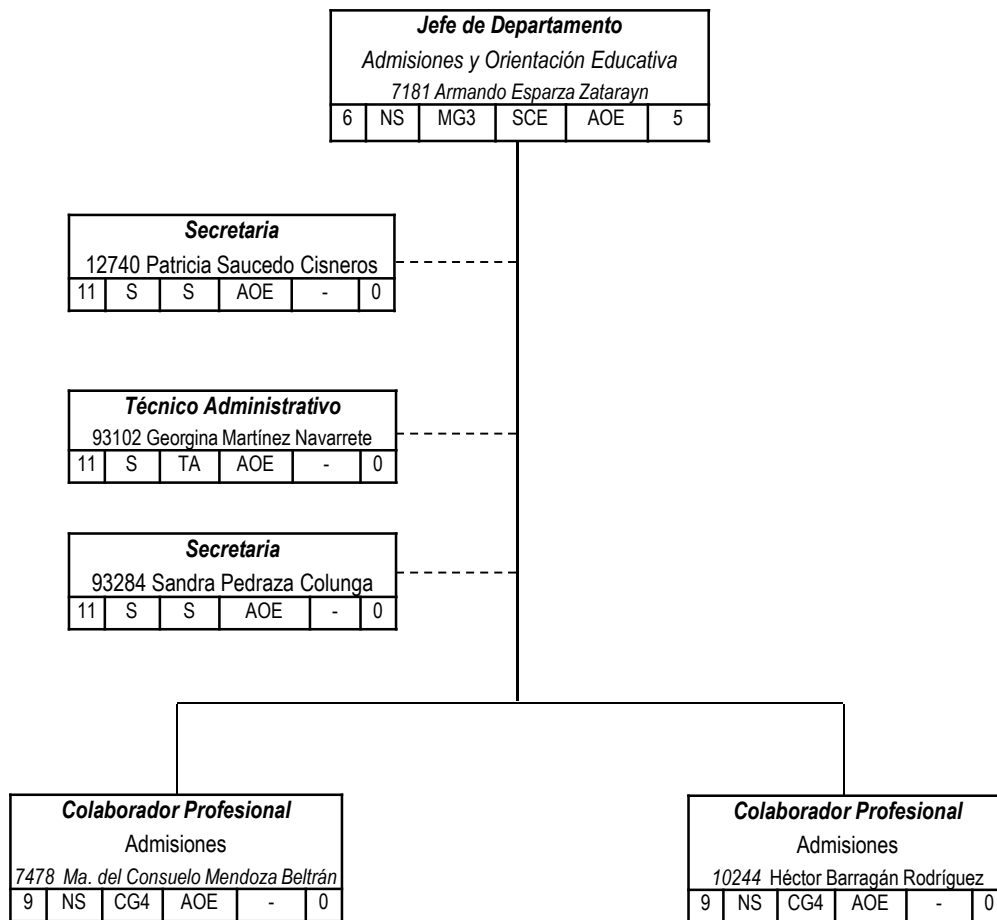



Unidad: **ADMINISTRACIÓN CENTRAL** Dependencia: **DIRECCIÓN DE ASUNTOS ACADÉMICOS**

<b>Jefe de Departamento</b>					
<i>Control Escolar</i>					
6625 Ramón Miguel Elizondo Domínguez					
6	NS	MG3	SCE	CE	26

<i>Secretaría</i>					
12450 Martha C. Sena Auces					
11	S	S	CE	-	0

<b>Encargado de Sección</b>					
<i>Control Escolar de Bachilleres Oficiales</i>					
8122 Gonzalo de León Jaramillo					
7	NS	MG8	CE	CEBO	6

<b>Encargado de Sección</b>					
<i>Control Escolar Licenciatura</i>					
11309 Manuel Reyes Díaz					
6	NS	MG3	CE	CEL	9

<b>Encargado de Sección</b>					
<i>Control Escolar de Posgrado</i>					
10835 Olimpia Garay Santos					
7	NS	MG8	CE	CEP	2

<b>Encargado de Sección</b>					
<i>Control Escolar de Escuelas Incorporadas</i>					
VACANTE					
7	NS	MG8	CE	CEEI	4



Unidad: **ADMINISTRACIÓN CENTRAL** Dependencia: **DIRECCIÓN DE ASUNTOS ACADÉMICOS**

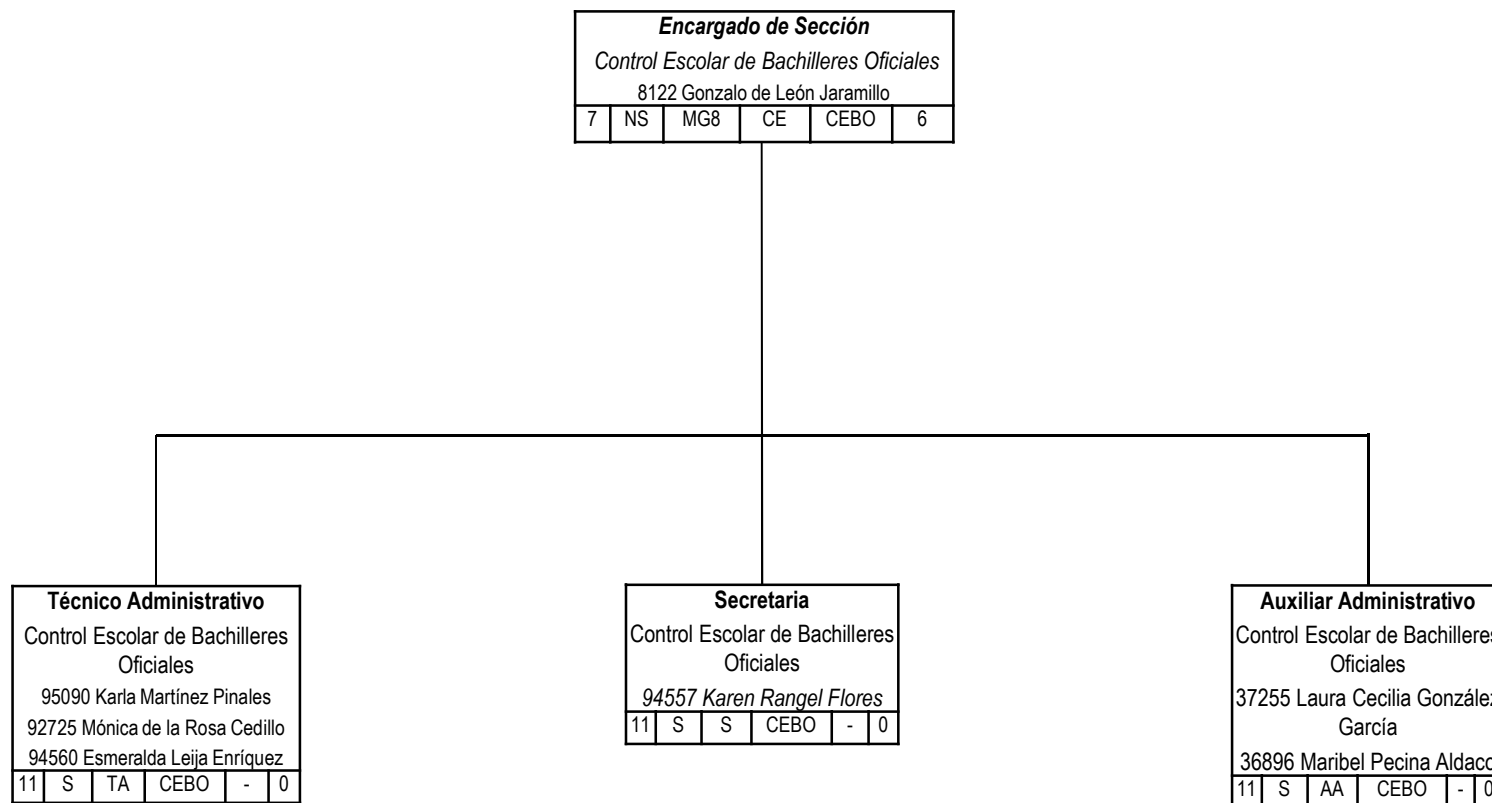





Unidad: **ADMINISTRACIÓN CENTRAL** Dependencia: **DIRECCIÓN DE ASUNTOS ACADÉMICOS**

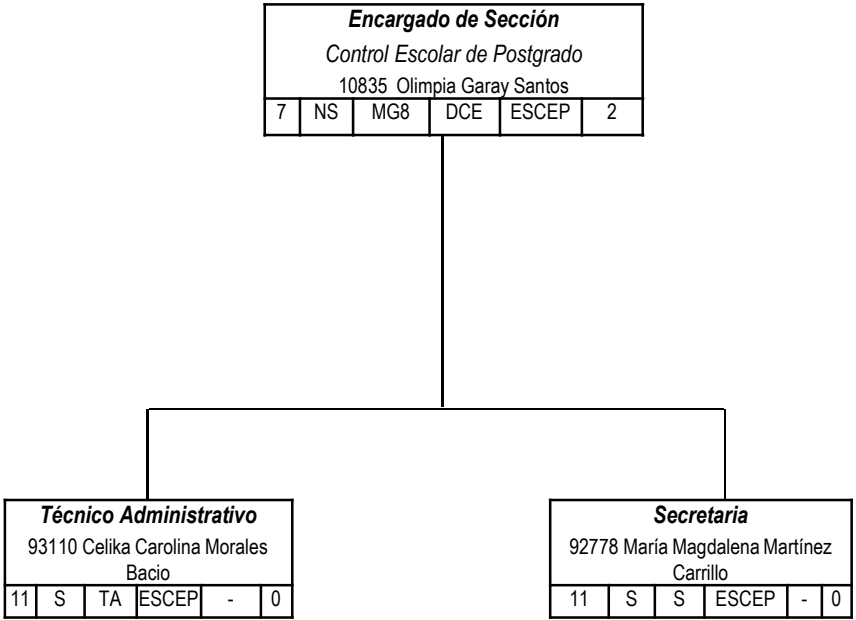



Unidad: **ADMINISTRACIÓN CENTRAL** Dependencia: **DIRECCIÓN DE ASUNTOS ACADÉMICOS**

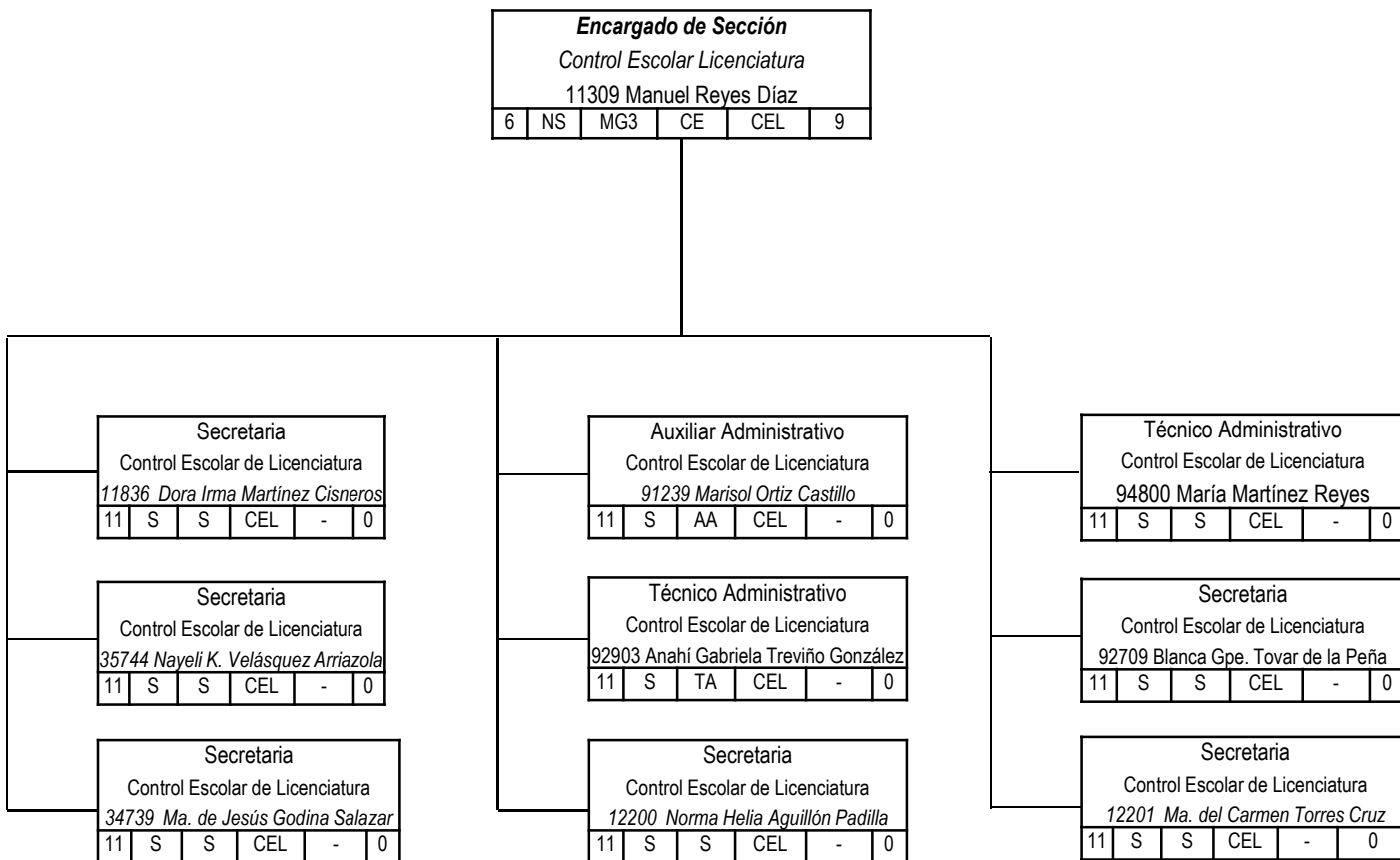



Unidad: **ADMINISTRACIÓN CENTRAL** Dependencia: **DIRECCIÓN DE ASUNTOS ACADÉMICOS**

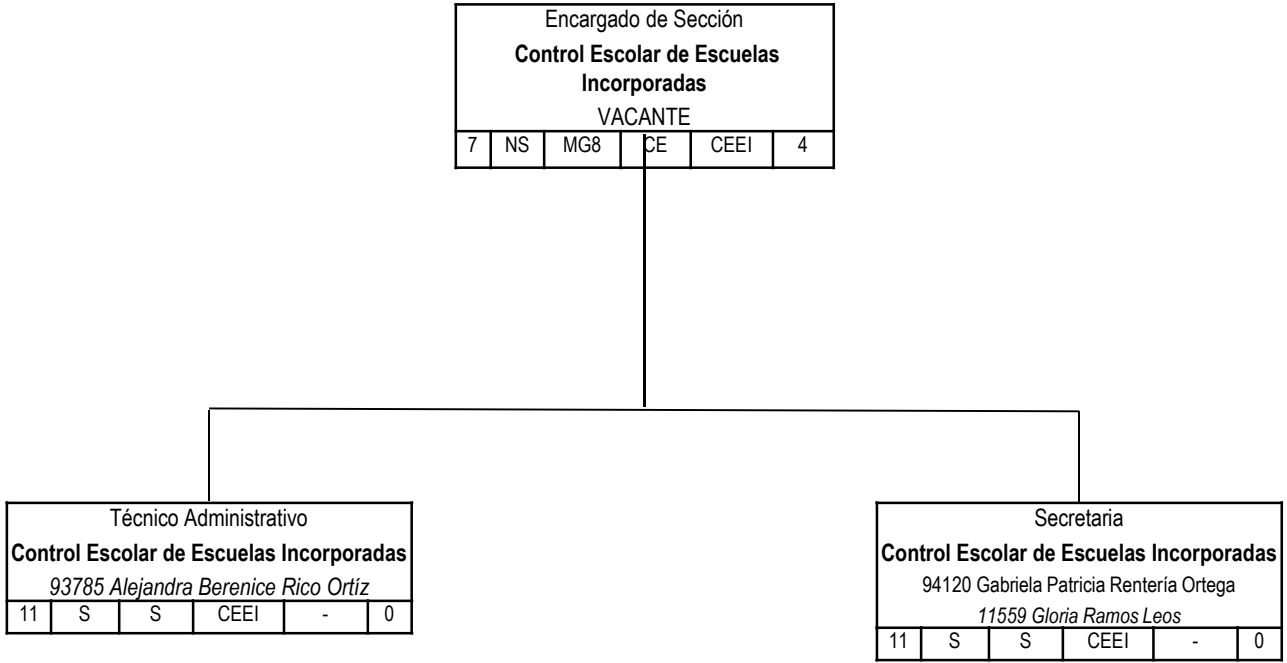



Unidad: **ADMINISTRACIÓN CENTRAL** Dependencia: **DIRECCIÓN DE ASUNTOS ACADÉMICOS**

<b>Jefe de Departamento</b>						
<i>Certificados, Títulos y Cédulas</i>						
36736 Aurora P. Gómez Yáñez						
6	NS	MG3	SCE	CTC		
14						

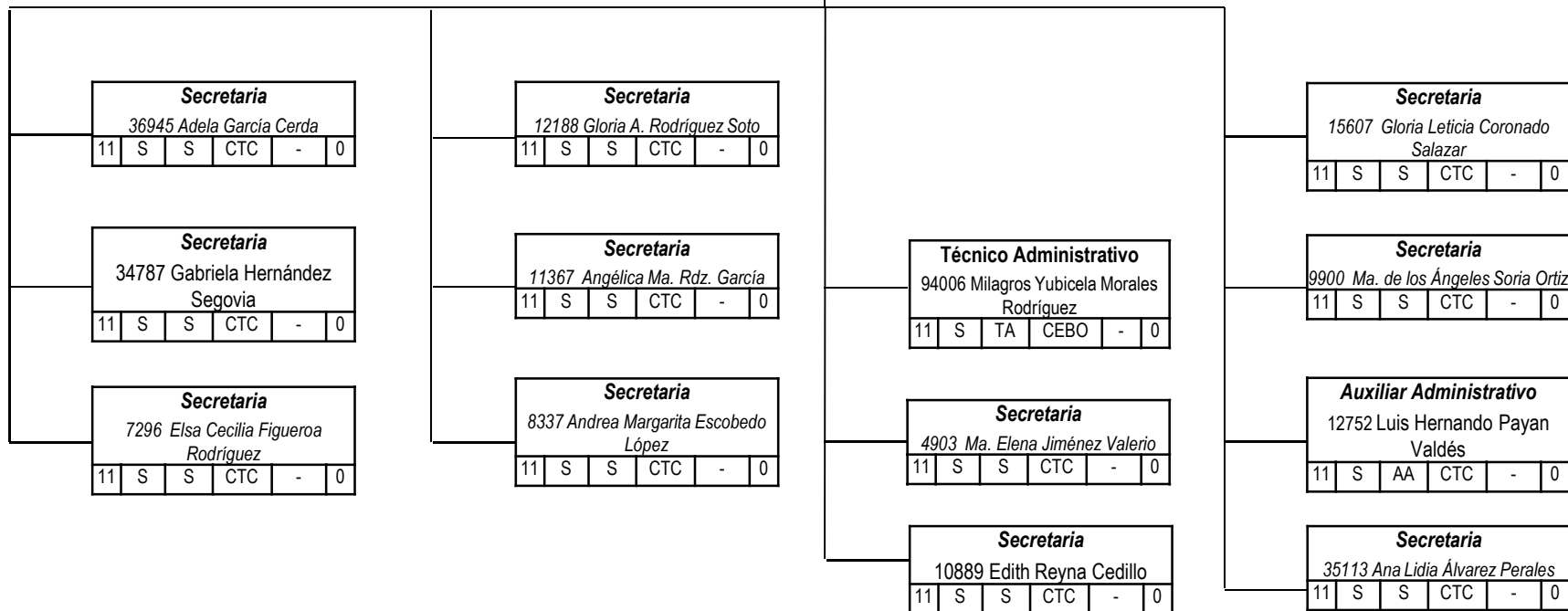



Unidad: **ADMINISTRACIÓN CENTRAL** Dependencia: **DIRECCIÓN DE ASUNTOS ACADÉMICOS**

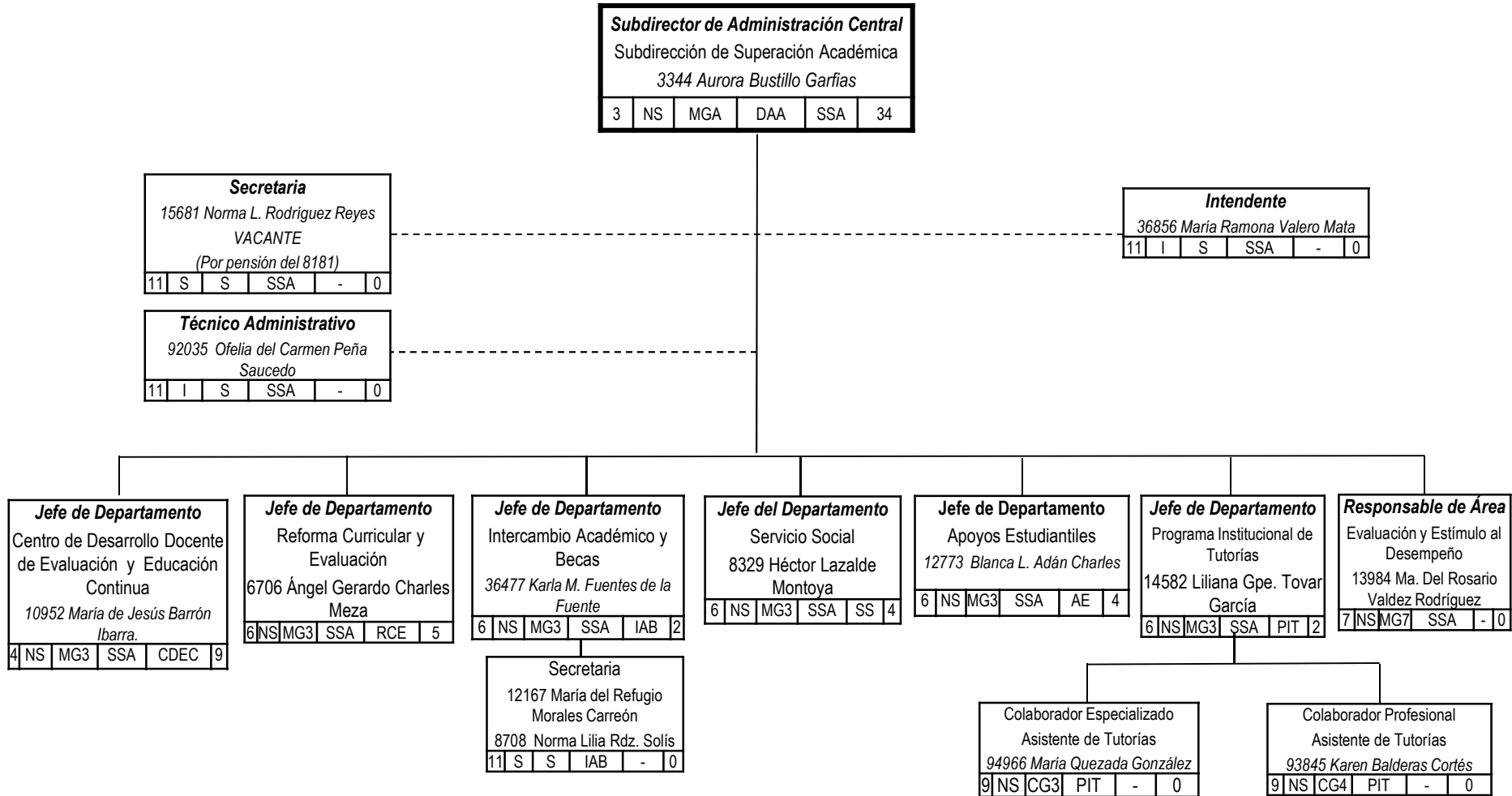



Unidad: **ADMINISTRACIÓN CENTRAL** Dependencia: **DIRECCIÓN DE ASUNTOS ACADÉMICOS**

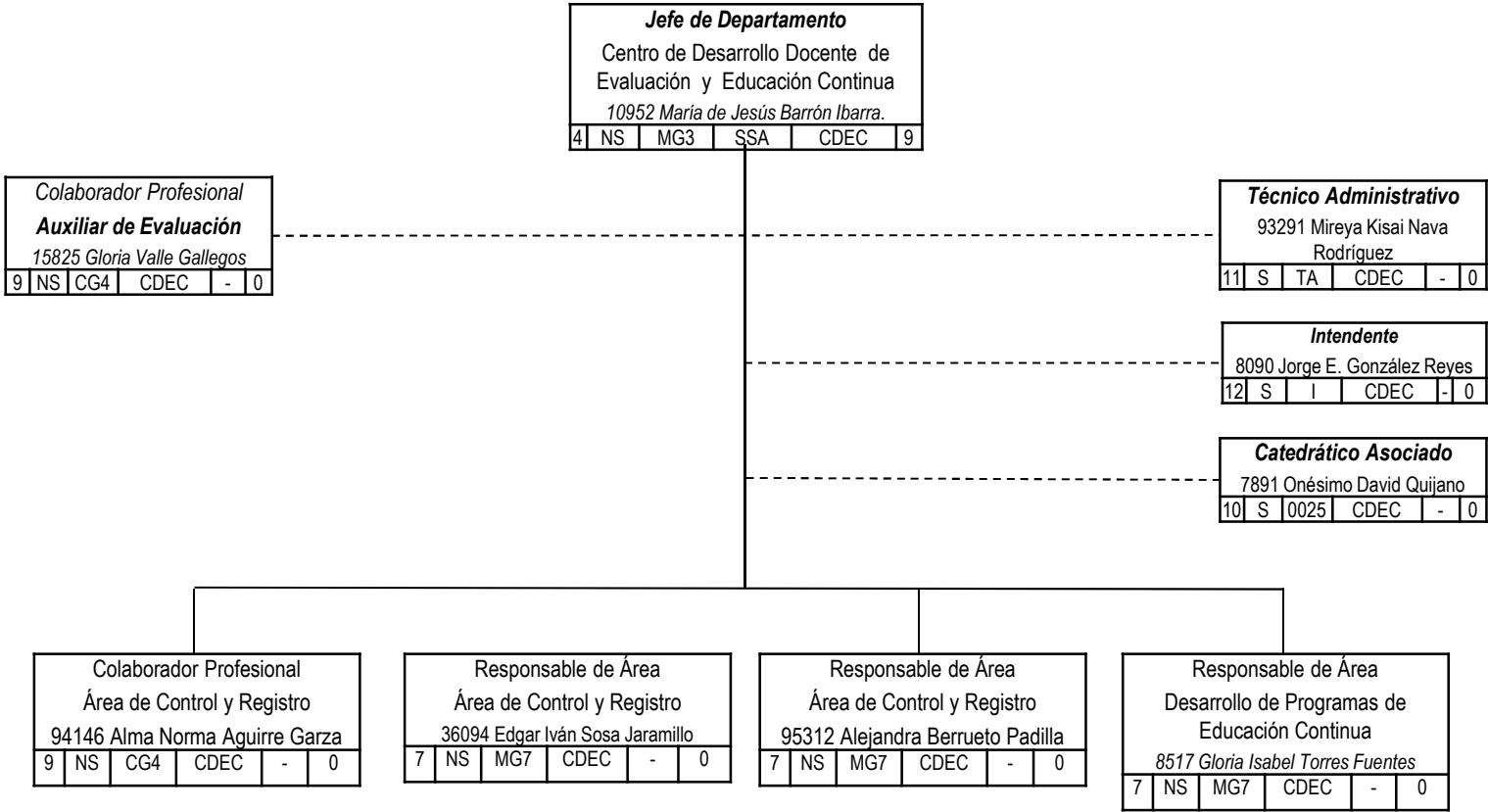



Unidad: **ADMINISTRACIÓN CENTRAL** Dependencia: **DIRECCIÓN DE ASUNTOS ACADÉMICOS**

Jefe de Departamento <b>Reforma Curricular y Evaluación</b> 6706 Ángel Gerardo Charles Meza					
6	NS	MG3	SSA	RCE	5

Colaborador Profesional <b>Asesor de Reforma Curricular</b> 7182 Alfredo Rocha Martínez 11251 Catalina García Montemayor 11346 Ma. Teresa de J. Carrillo Hernández 7183 Ricardo Esquivel Peña 92914 Liliana Ramos Terán					
9	NS	CG4	RCE	-	0



Unidad: **ADMINISTRACIÓN CENTRAL** Dependencia: **DIRECCIÓN DE ASUNTOS ACADÉMICOS**

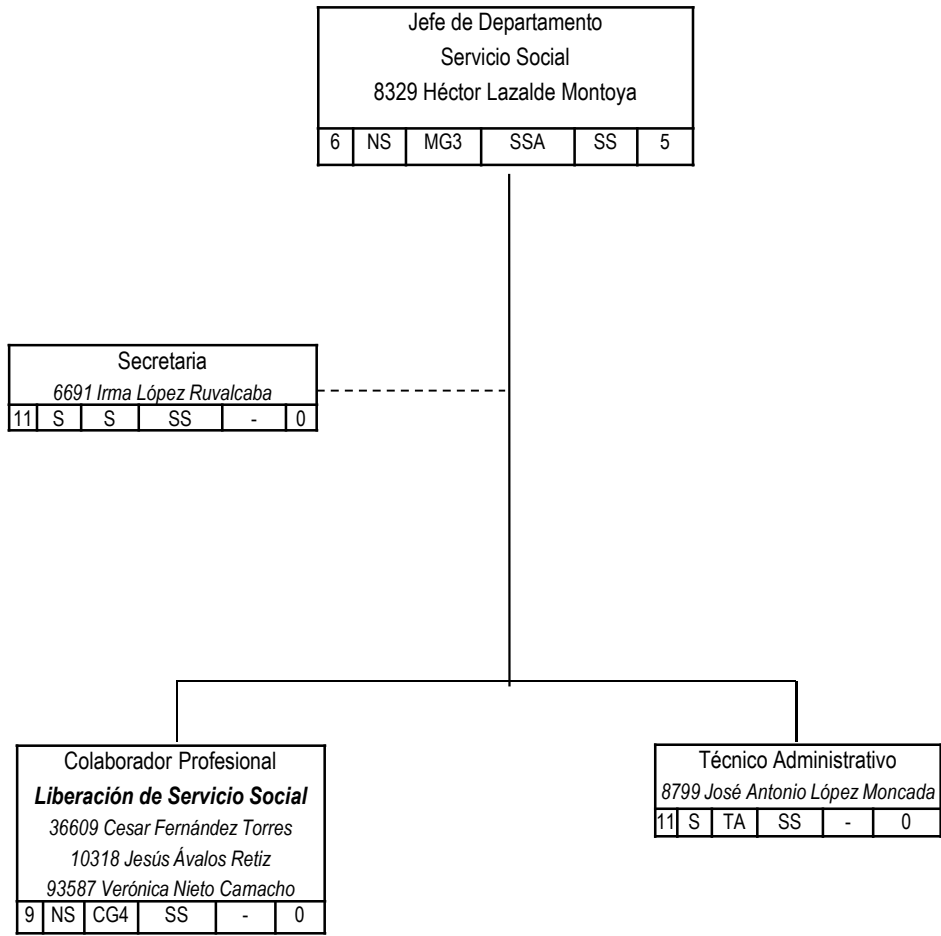





Unidad: **ADMINISTRACIÓN CENTRAL** Dependencia: **DIRECCIÓN DE ASUNTOS ACADÉMICOS**

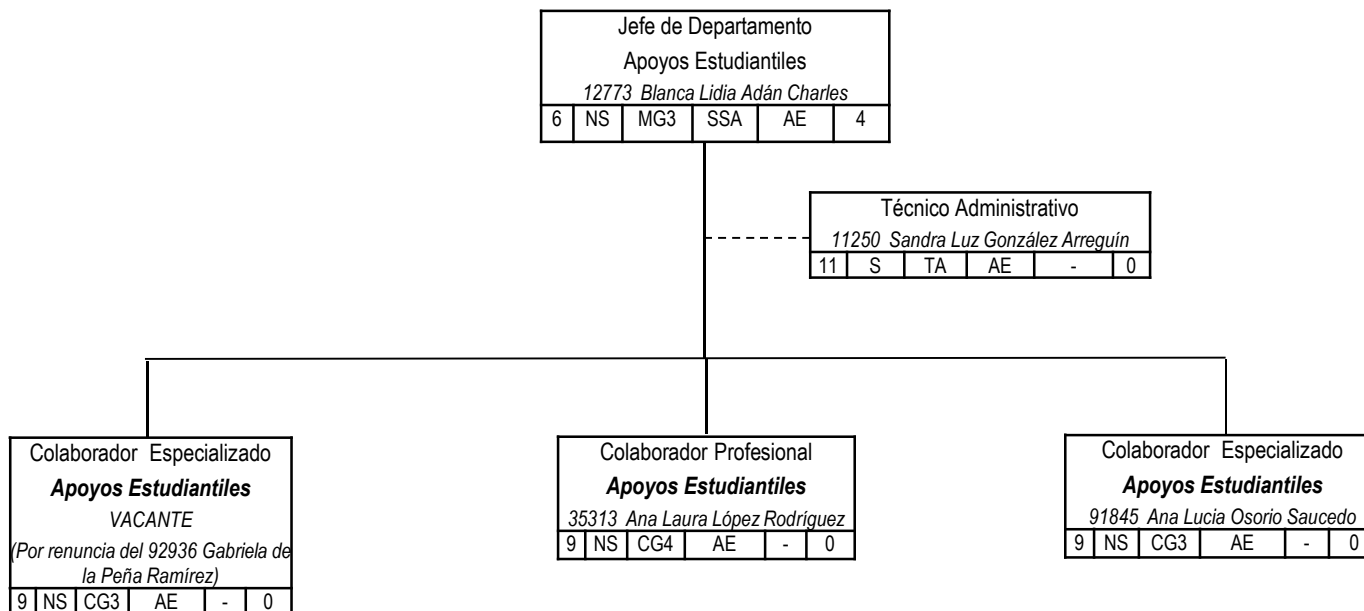



Unidad: **ADMINISTRACIÓN CENTRAL** Dependencia: **DIRECCIÓN DE ASUNTOS ACADÉMICOS**

<b>Coordinador de Gestión Universitaria</b>						
Coordinación de Inglés Curricular						
14928 Aida Marisol Medina Quiroga						
4	NS	MSB	DAA	CIC	136	

<b>Asistente de Administración</b>						
12221 Laura E. Romero Gómez						
10	NS	CG2	CIC	-	0	

<b>Responsable de Área</b>						
Área Administrativa						
92646 Claudia K. López Díaz.						
7	NS	MG7	CIC	-	0	

<b>Jefe de Departamento</b>						
Inglés Curricular UT						
17226 Marisol Fernández Zetina						
6	NS	MG3	CIC	ICUT	45	

<b>Jefe de Departamento</b>						
Inglés Curricular Unidad Saltillo						
17071 Melina García Flores						
6	NS	MG3	CIC	ICUS	51	

<b>Jefe de Departamento</b>						
Inglés Curricular UN						
14175 Martha Lorena Flores						
6	NS	MG3	CIC	ICUN	34	

<b>Responsable de Área</b>						
Área Administrativa						
92845 Ana Isabel Torano Ramírez						
7	NS	MG7	ICUT	-	0	

<b>Responsable de Área</b>						
Área Académica IC UT						
17098 Said Artea Favela						
7	NS	MG7	ICUT	AICUT	42	

<b>Responsable de Área</b>						
Área académica IC Unidad Saltillo						
17079 Gizella Noriki Ortiz Hernández						
7	NS	MG7	ICUS	AICS	49	

<b>Responsable de Área</b>						
Área administrativa IC UN						
91959 Julieta Flores Vázquez						
7	NS	MG7	ICUN	-	0	

<b>Responsable de Área</b>						
Área Académica IC Unidad Norte						
17088 Yessika Martínez						
7	NS	MG7	ICUN	AICUN	31	

<b>Responsable de Área</b>						
Control Escolar IC UT						
92844 Elda Leticia Chapa Rivera						
7	NS	MG7	ICUT	-	0	

<b>Catedrático</b>						
Planta Docente						
Unidad Torreón						
Ver en hoja 19						

<b>Responsable de Área</b>						
Control Escolar IC US						
VACANTE						
7	NS	MG7	ICUS	-	0	

<b>Catedrático</b>						
Planta Docente						
Unidad Saltillo						
Ver en hoja 19						

<b>Responsable de Área</b>						
Control Escolar IC UN						
14176 Laura Argelia Garza C.						
7	NS	MG7	DICUN	-	0	

<b>Catedrático</b>						
Planta Docente						
Unidad Norte						
Ver en hoja 19						



Unidad: **ADMINISTRACIÓN CENTRAL** Dependencia: **DIRECCIÓN DE ASUNTOS ACADÉMICOS**

<b>Catedrático</b>					
Planta Docente					
<b>Unidad Torreón</b>					
15204	Sonia	Perales	Esponza		
16260	Sergio	López	Hernández		
17096	Ernesto	Almaguer	Rodríguez		
17097	Abraham	Arellano	Avalos		
17099	Nidia	Barraza	de León		
17100	Flavia	Irene	Casale Villarreal		
17102	Mayra	Cecilia	Cueto Hernández		
17104	Alma	Elizabeth	Gallegos García		
17107	Patricia	Lara	Galván		
17109	Arturo	Eduardo	Martínez Moran		
17110	Luis	Alfonso	Morari Quezada		
93519	María	Cristina	Ortega Gutiérrez		
92111	Ingrid	Rodríguez	Puebla		
92382	Juan	Gustavo	Ibarra Montañez		
92112	Alberto	Fong	Reza		
91170	Ana	Cecilia	Silveyra Rodarte		
91168	Hiram	González	Montemayor		
36825	Brenda	Fraire	Domínguez		
36664	Rosa	Cecilia	Quintana Saldaña		
36438	Gabriela	Quintana	Saldaña		
36287	Tathya	Mendoza	Rodríguez		
17388	Luis	Miguel	Escobedo López		
17334	Gabriela	Seañes	de Villa		
17321	María	Luisa	Alcalde Ramírez		
17290	Raúl	Batres	Limón		
17289	Irma	Pedroza	Sánchez		
17278	Erika	Sanmiguel	Gutiérrez		
10	NS	J21	AICT	-	0

<b>Catedrático</b>					
Planta Docente					
<b>Unidad Torreón</b>					
17230	Miriam	Valencia	Soto		
17229	Jorge	Ramírez	Pérez		
17222	Brenda	García	Zambrano		
17212	Gladys	Ramírez	Aguilera		
17115	Rodolfo	Zugasti	Escobar		
17114	Andrés	Sánchez	Maltos		
17111	Laura	Ortiz	Valdez		
93518	María	Márquez	Rodríguez		
15854	José	Refugio	López Jasso		
17106	Martín	Juárez	García		
17273	Carlo	Cortés	Márquez		
91728	Jessica	Canela	Frayre		
93598	San	Juanita	Rodríguez Flores		
93832	Juan	José	Silveyra Lira		
94192	Darío	Espino	Palacios		
94193	Luis	Calderón	Rodríguez		
94194	Rocío	García	Dávila		
98110	Nayeli	Marivi	Lozano		
93516	Sandra	González	Romero		
95115	José	Alberto	García Dávila		
91977	Juan	Antonio	Nevaras Ceballos		
10	NS	J21	AICT	-	0

<b>Catedrático</b>					
Planta Docente					
<b>Unidad Saltillo</b>					
4506	Astrid	Naranjo	López		
14191	Hernán	Valdés	Ramos		
17298	Manuel	García	Ramos		
17299	Carolina	Mazatán	Cárdenas		
17328	Violeta	Verónica	Rosas Rivas		
17329	Azucena	Rosas	Rivas		
17330	Cecilia	Agüero	Marrufo		
17338	Sandra	Nely	Ochoa Zamora		
14076	Noé	Flores	Flores		
92586	Miriam	Martínez	Martínez		
36901	Marco	Antonio	Canales Villarreal		
36903	Jessica	Rodríguez	Neavez		
36905	Luz	Ramos	Ballesteros		
36906	Miguel	Ángel	Ramos Arias		
91162	Teresa	Coronado	Ortiz		
91163	Andrea	Galván	Longoria		
91185	David	Medina	Galván		
91646	Alma	Mtanous	Villarreal		
91662	Elsa	Norma	Rodríguez González		
92208	Blanca	Yazmín	Acosta Luna		
92226	Dora	Elia	Nicolás Ramos		
92367	Andrea	Alejo	Cavazos		
17397	Eunice	Salas	Pérez		
17215	Magaly	Ramos	Fernández		
10	NS	J21	AICS	-	0

<b>Catedrático</b>					
Planta Docente					
<b>Unidad Saltillo</b>					
92161	Rosalba	Mabel	Suarez Torres		
34069	Arturo	Antonio	Urrea Barrientos		
15444	Eva	Luisa	Arias Hernández		
15841	Leslie	González	García		
16862	Humberto	Sánchez	Neira		
17068	Martha	María	Apolinar Galván		
17072	Diana	Fernández	Elguezabal		
17076	Martha	Maldonado	Valenzuela		
17077	Julio	Raymundo	Martínez Gómez		
17078	Jonathan	Melo	Ponce		
17143	Paloma	Amanda	Alvarado Cárdenas		
17214	Mauren	Elizabeth	Morales Jaramillo		
17216	Evelyn	Tijerina	Pérez		
94453	Erika	Carrizales	Ruiz		
94460	Omar	Rangel	Primerio		
94461	Leslie	Almazan	López		
94787	Victoria	Álvarez	González		
94802	Scarlett	Martínez	Delgado		
94929	Dilayla	García	Rodríguez		
94923	Pedro	López	Requena		
93655	Cesar	Chávez	Rodríguez		
95169	María	Torres	Lara		
93160	Emma	Hernández	Cazaes		
95166	Juan	Bernal	Contreras		
95097	Diego	Cortez	Aguilera		
10	NS	J21	AICS	-	0

<b>Catedrático</b>					
Planta Docente					
<b>Unidad Norte</b>					
16567	Cesar	Israel	Zúñiga Hernández		
17089	Raymur	Fuentes	Alvarado		
17090	José	Antonio	Jiménez Pérez		
17091	Brenda	Janeth	Méndez Sosa		
17093	Elsa	Galván	Estrada		
17094	Juan	José	Rodríguez González		
17095	Monica	Violette	Udave Estefan		
17217	Griselda	Martínez	Vaquera		
17218	Alba	Patricia	Méndez García		
17220	Narda	Mónica	Torvisco Castillo		
17306	Gilberto	Hidalgo	Cano		
17310	Sandra	Luz	Coronado Sánchez		
17312	Sonia	Mendoza	De La Garza		
17346	Evelyn	Alicia	Garza Hernández		
17372	Ana	Elizabeth	Aldaco Domínguez		
17373	Juan	Ángel	Bustos Avendaño		
17376	Hilda	Lizeth	Torres González		
91224	Jorge	Bracho	Gutiérrez		
91398	Leticia	González	Valdez		
91516	Ana	Rosa	Flores Rivera		
91655	Daniela	Hidalgo	Carmona		
91676	Diana	Margarita	Robles Quintanilla		
91827	Gabriela	Yvonne	López Lozano		
92105	Alma	Leticia	Castillón Carrales		
92107	Francisco	Javier	Ortiz Moreno		
92354	Esther	Ruiz	Saldaña		
92355	Mónica	Flores	Turrubiate		
93132	Monsivais	Niebla	Carlos Marxemil		
91240	Victoria	Garza	Boardman		
93810	Carlos	Puente	Prado		
94162	Marcela	Mc Gregor	Campuzano		
94163	Elena	Garza	Hernández		
94452	Claudia	Charles	Huerta		
94786	Ramiro	Urbina	de los Reyes		
94843	Seli	Mendiola	Duran		
95075	Mayela	Lozano	Garza		
10	NS	J21	AICN	-	0



Unidad: **ADMINISTRACIÓN CENTRAL** Dependencia: **DIRECCIÓN DE ASUNTOS ACADÉMICOS**

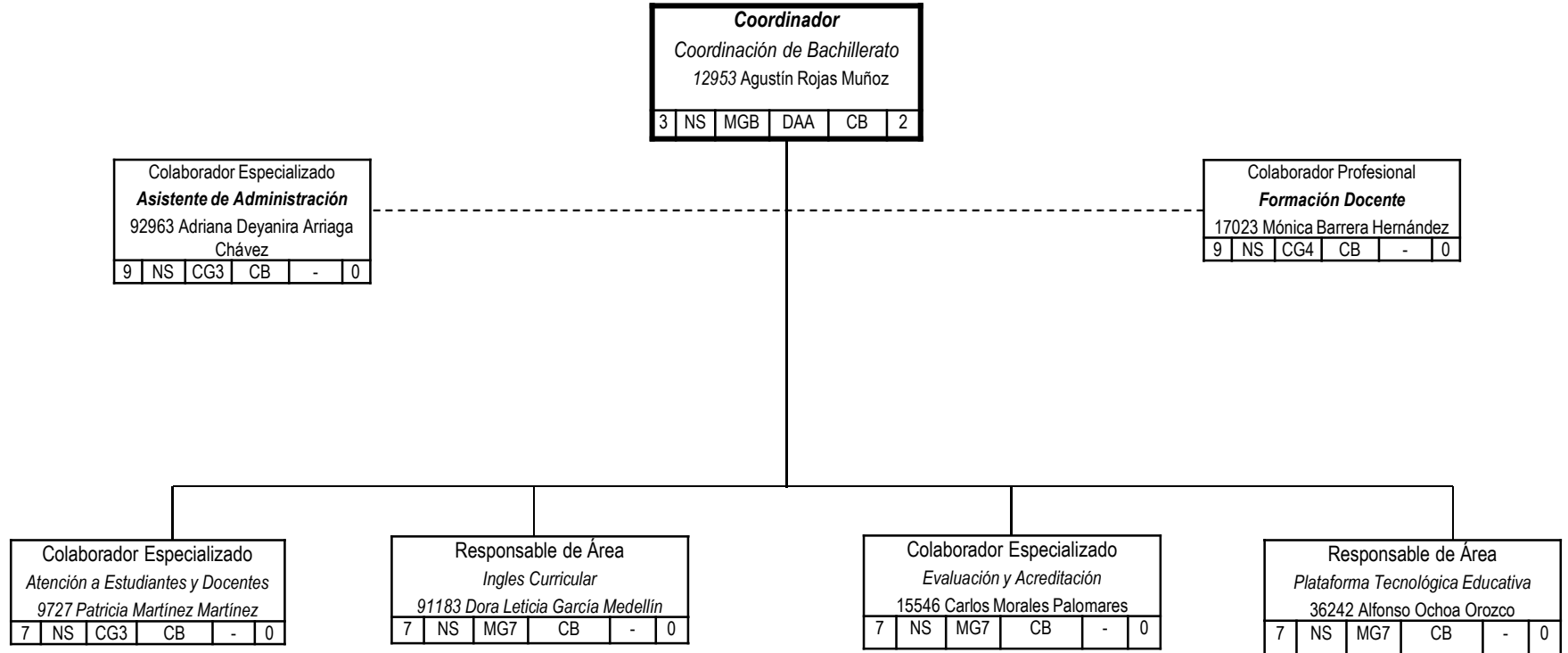



Unidad: **ADMINISTRACIÓN CENTRAL** Dependencia: **DIRECCIÓN DE ASUNTOS ACADÉMICOS**

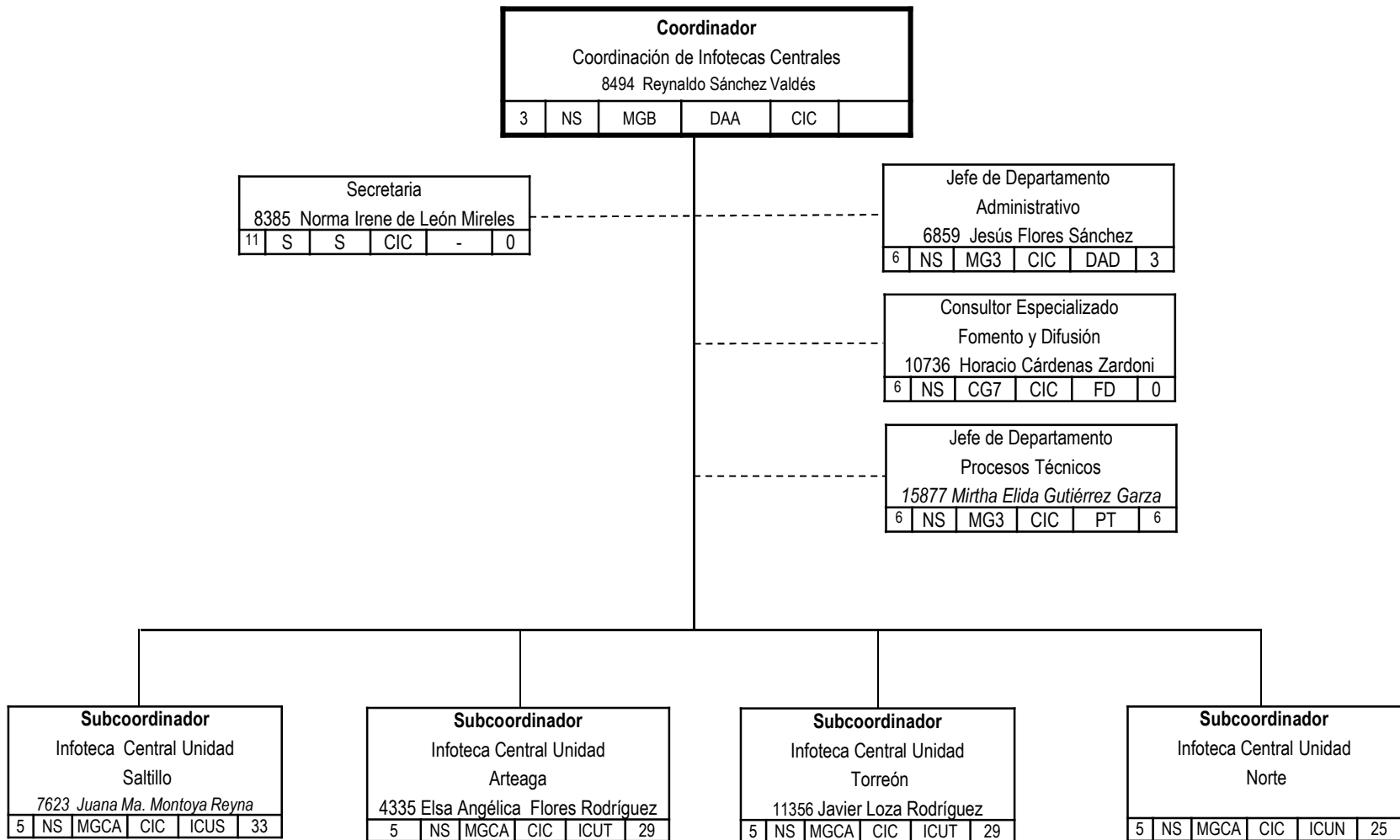



Unidad: **ADMINISTRACIÓN CENTRAL** Dependencia: **DIRECCIÓN DE ASUNTOS ACADÉMICOS**

<b>Coordinador</b>					
Coordinación de Infotecas Centrales					
8494 Reynaldo Sánchez Valdés					
3	NS	MGB	DAA	CIC	26

<b>Jefe de Departamento</b>					
Infoteca de la Salud					
14171 Patricia G. González Sánchez					
6	NS	MG3	CIC	IS	7

<b>Jefe de Departamento</b>					
Infoteca Campus Poniente					
14180 María del Carmen Rodríguez Machorro					
6	NS	MG3	CIC	ICP	5

<b>Jefe de Departamento</b>					
Centro de Informática de Nueva Rosita					
4365 Juan Fernando Berrones Peña					
7	NS	MG8	CIC	CINR	10



Unidad: **ADMINISTRACIÓN CENTRAL** Dependencia: **DIRECCIÓN DE ASUNTOS ACADÉMICOS**

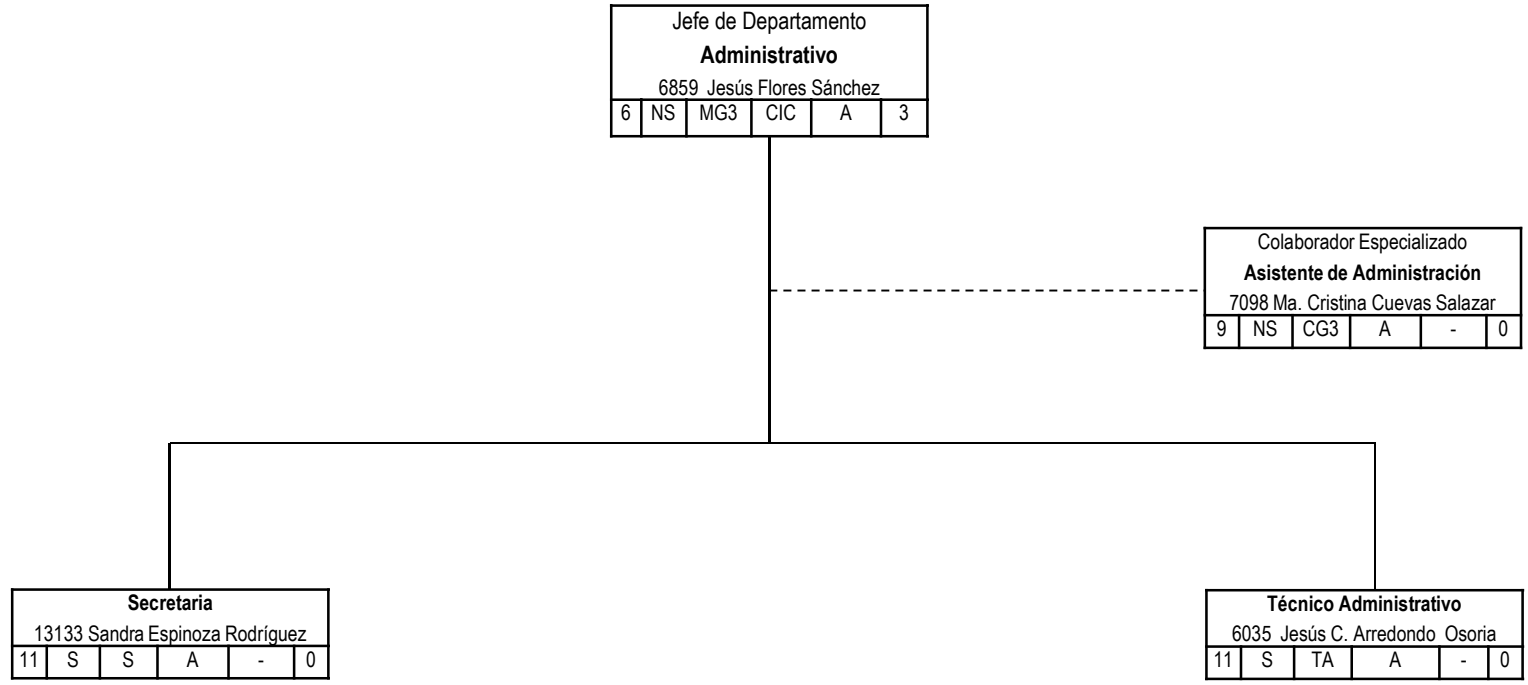



Unidad: **ADMINISTRACIÓN CENTRAL** Dependencia: **DIRECCIÓN DE ASUNTOS ACADÉMICOS**

Consultor Especializado					
<b>Fomento y Difusión</b>					
<i>10736 Horacio Cárdenas Zardoni</i>					
6	NS	CG7	CIC	FD	0

Colaborador Profesional					
<b>Auxiliar de Fomento, Difusión y Calidad</b>					
<i>92516 María Elizabeth Márquez Serna</i>					
9	NS	CG4	FD	-	0





Unidad: **ADMINISTRACIÓN CENTRAL** Dependencia: **DIRECCIÓN DE ASUNTOS ACADÉMICOS**

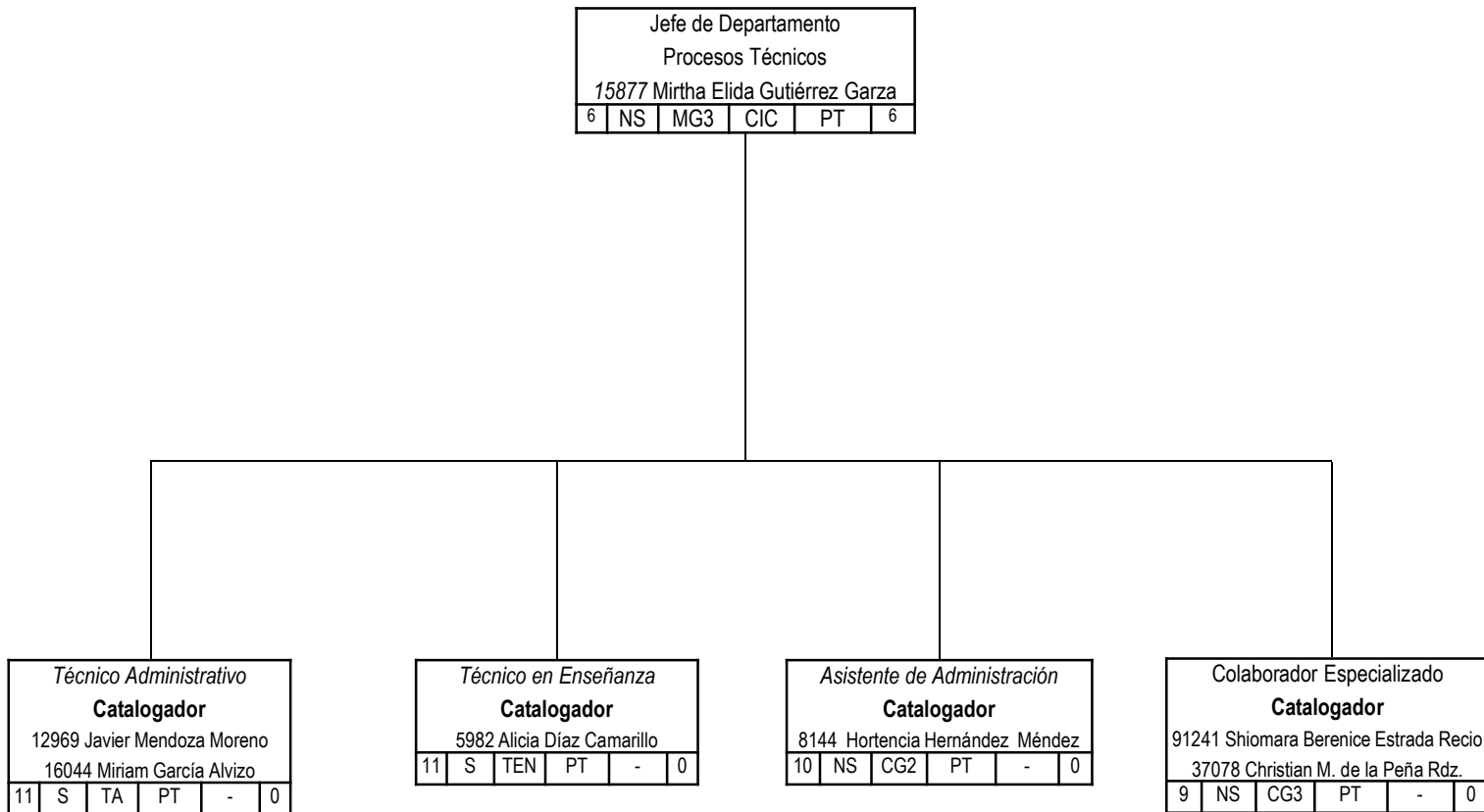



Unidad: **ADMINISTRACIÓN CENTRAL** Dependencia: **DIRECCIÓN DE ASUNTOS ACADÉMICOS**

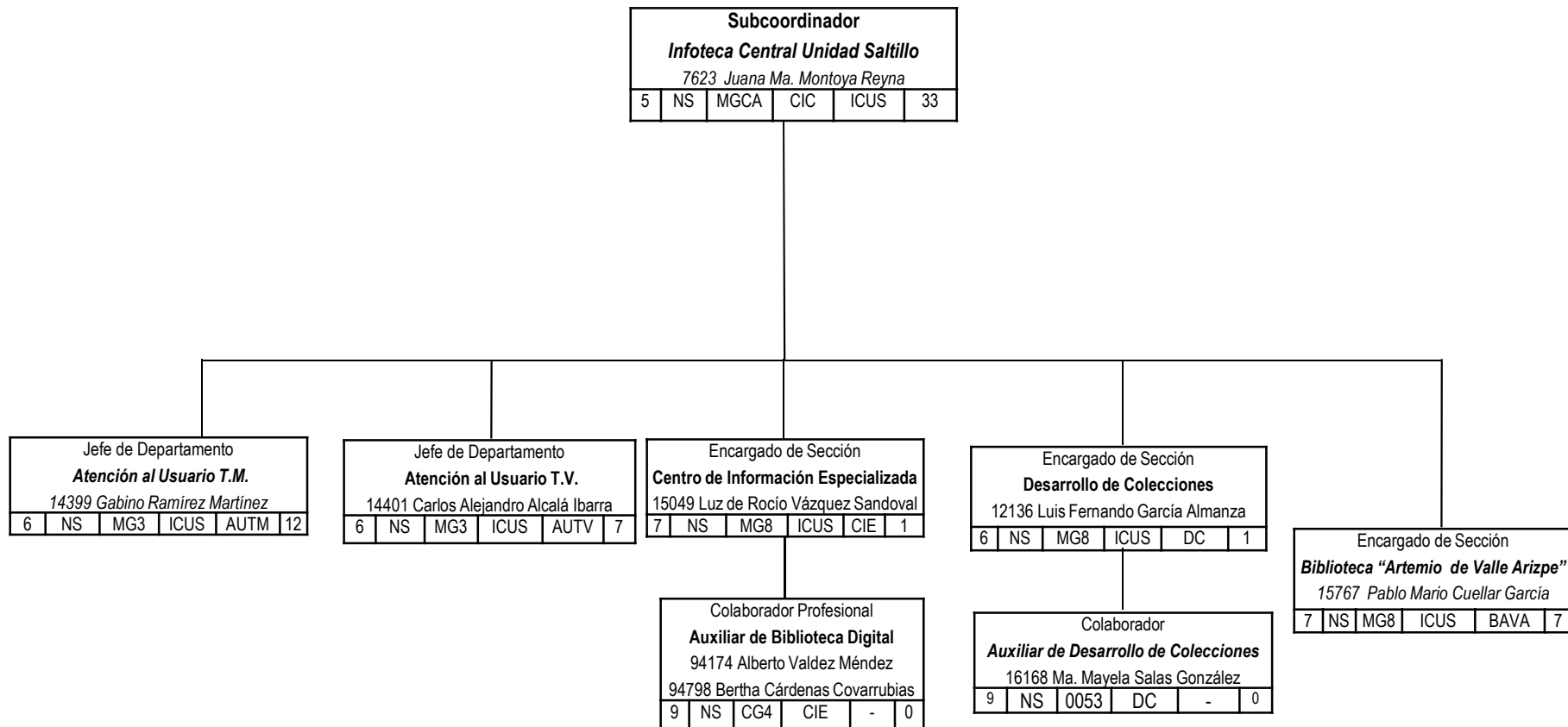



Unidad: **ADMINISTRACIÓN CENTRAL** Dependencia: **DIRECCIÓN DE ASUNTOS ACADÉMICOS**

Jefe de Departamento					
<b>Atención al Usuario T.M.</b>					
14399 Gabino Ramírez Martínez					
6	NS	MG3	ICUS	AUTM	12

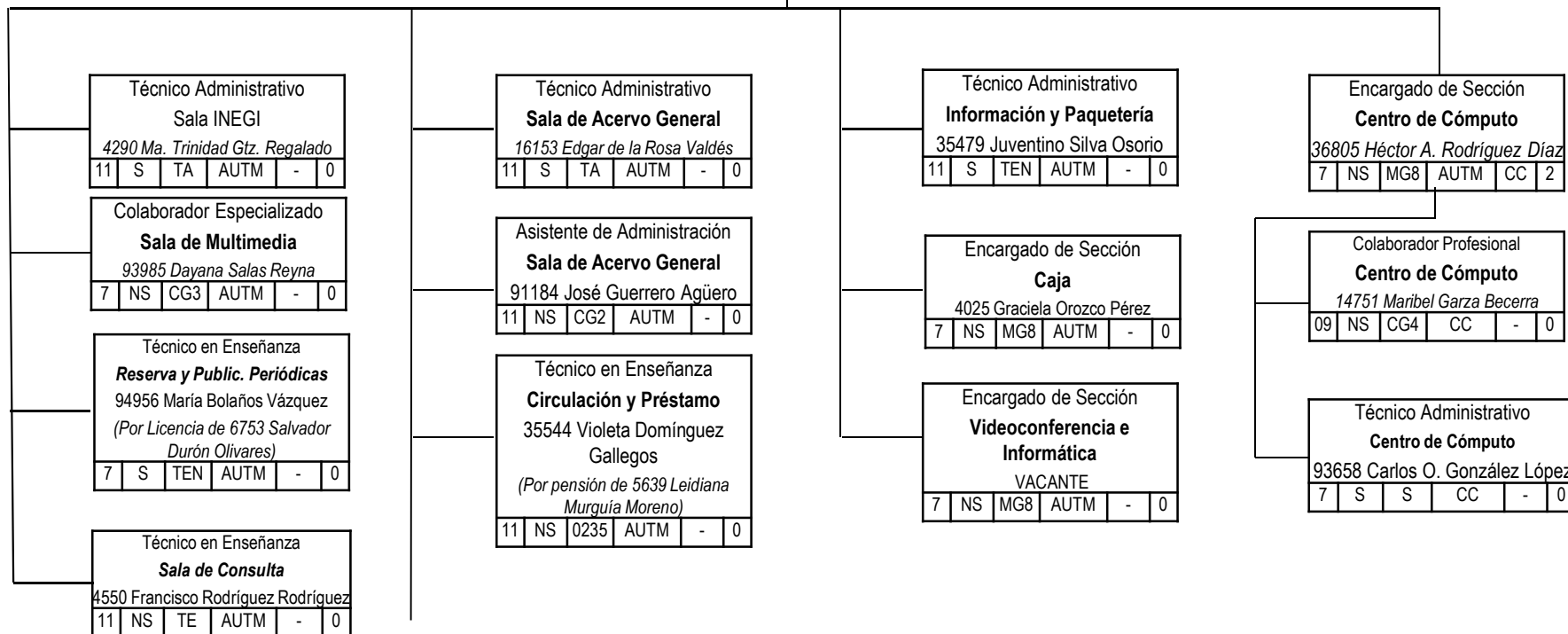



Unidad: **ADMINISTRACIÓN CENTRAL** Dependencia: **DIRECCIÓN DE ASUNTOS ACADÉMICOS**

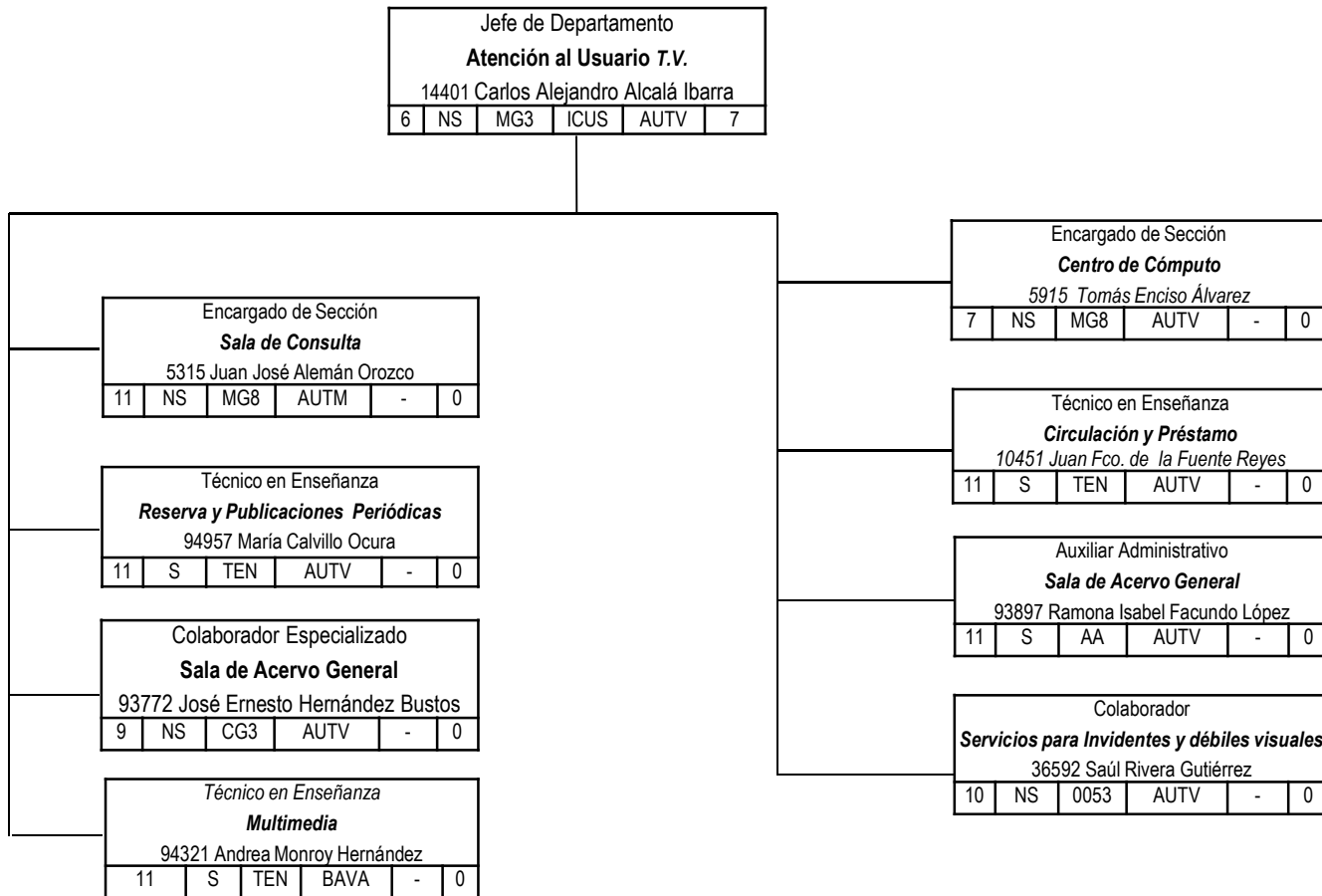



Unidad: **ADMINISTRACIÓN CENTRAL** Dependencia: **DIRECCIÓN DE ASUNTOS ACADÉMICOS**

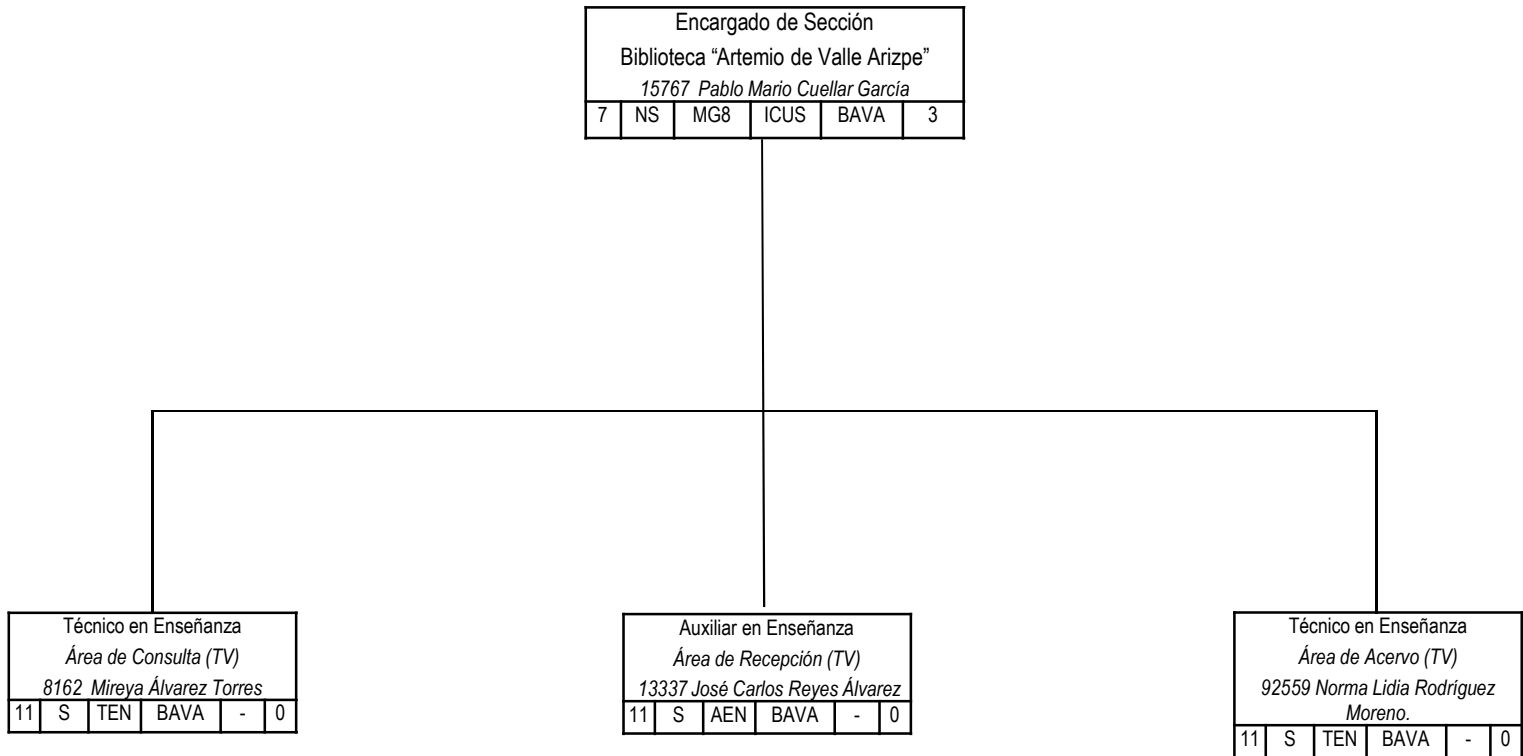



Unidad: **ADMINISTRACIÓN CENTRAL** Dependencia: **DIRECCIÓN DE ASUNTOS ACADÉMICOS**

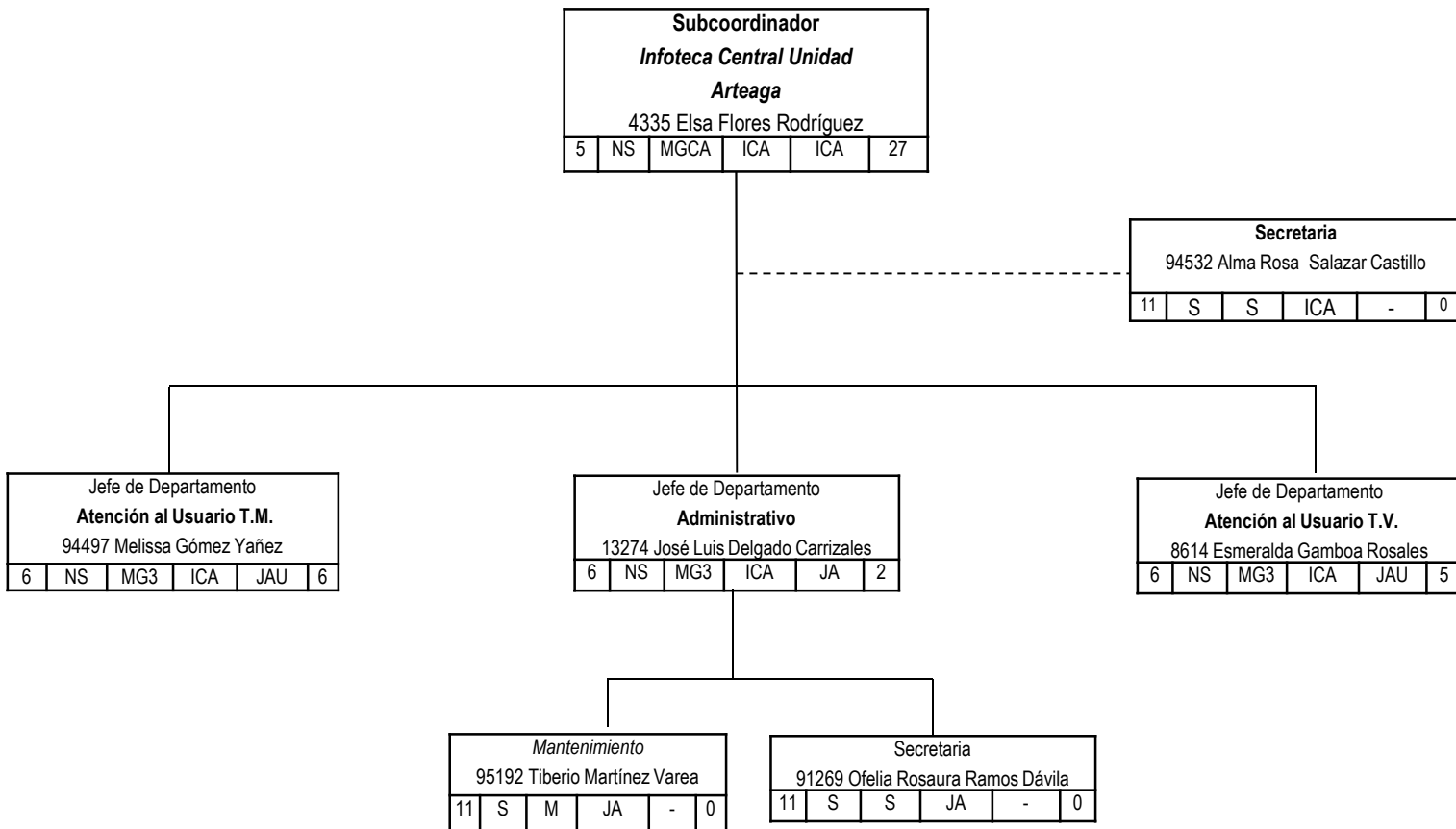



Unidad: **ADMINISTRACIÓN CENTRAL** Dependencia: **DIRECCIÓN DE ASUNTOS ACADÉMICOS**

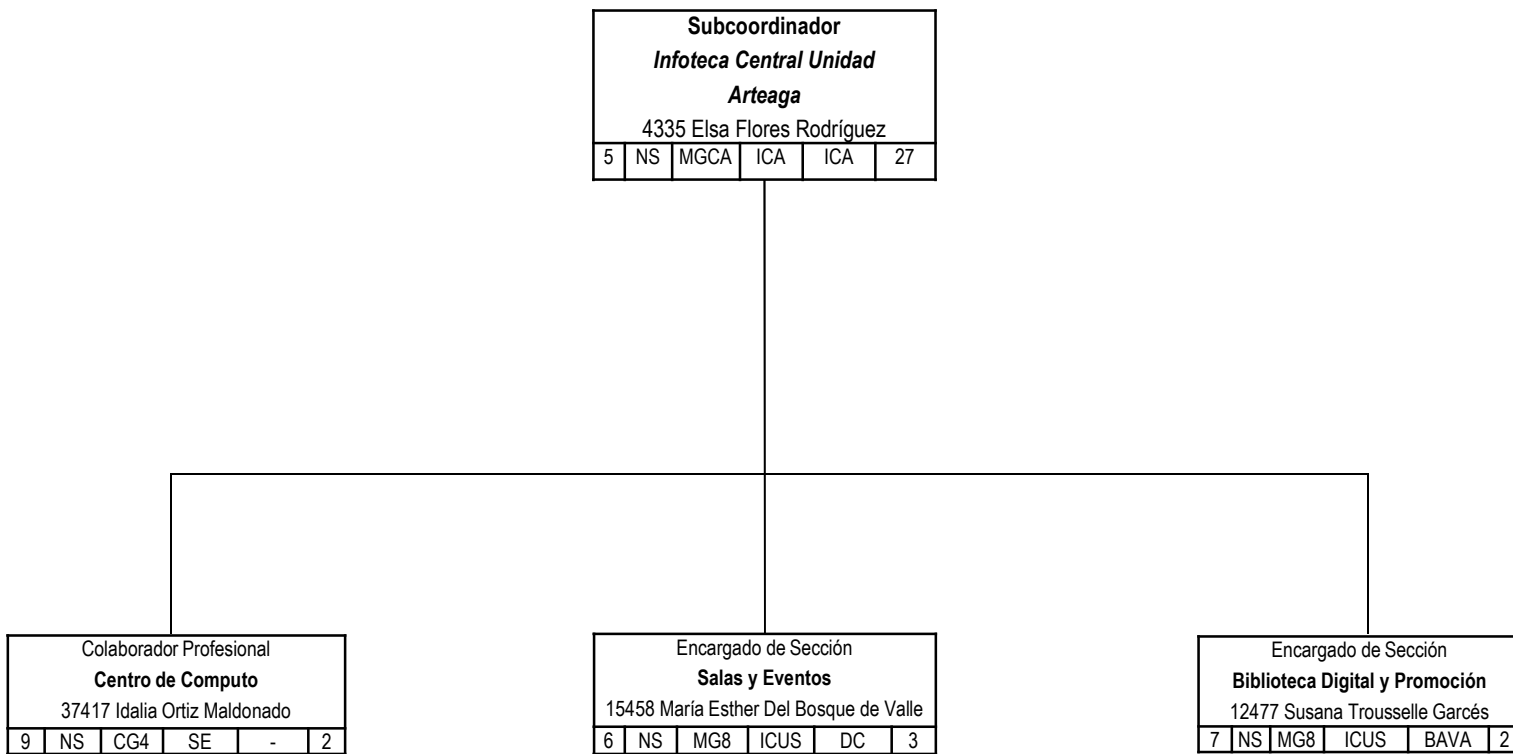



Unidad: **ADMINISTRACIÓN CENTRAL** Dependencia: **DIRECCIÓN DE ASUNTOS ACADÉMICOS**

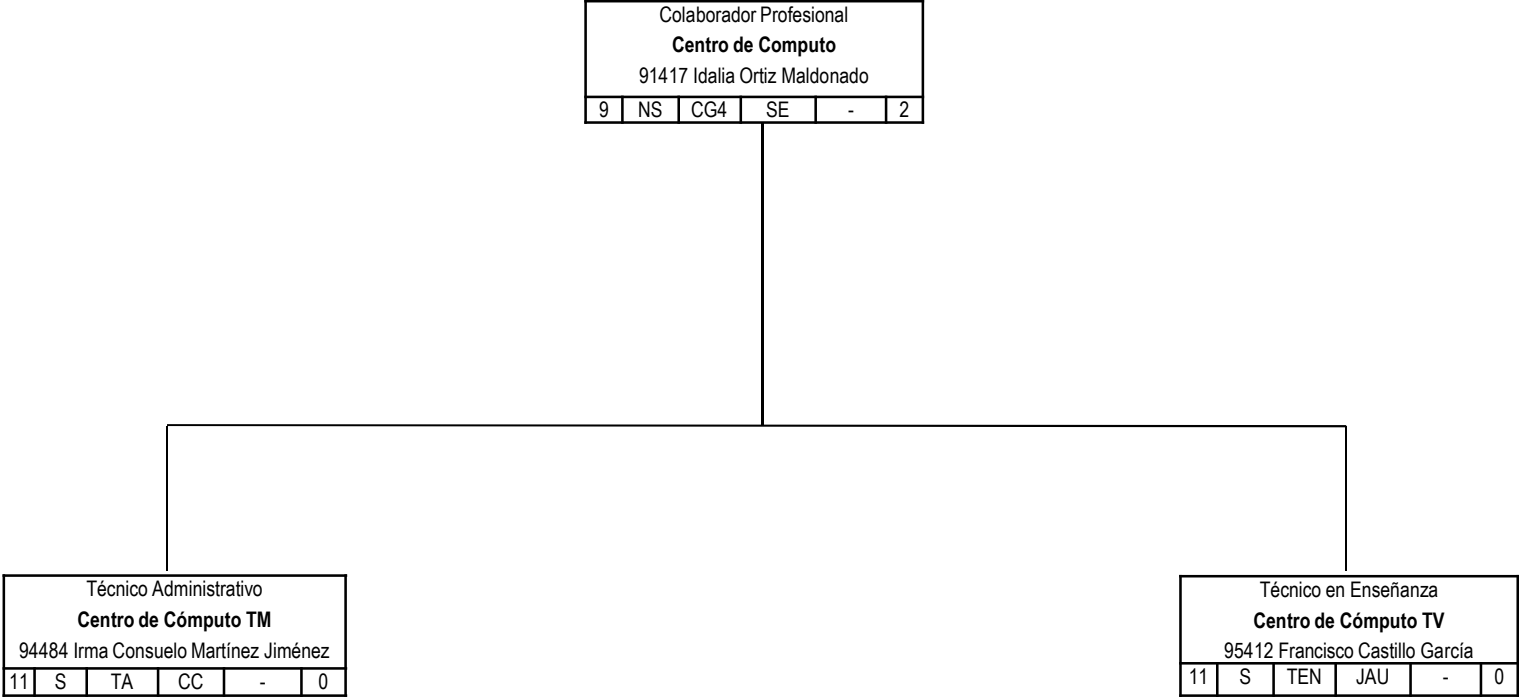





Unidad: **ADMINISTRACIÓN CENTRAL** Dependencia: **DIRECCIÓN DE ASUNTOS ACADÉMICOS**

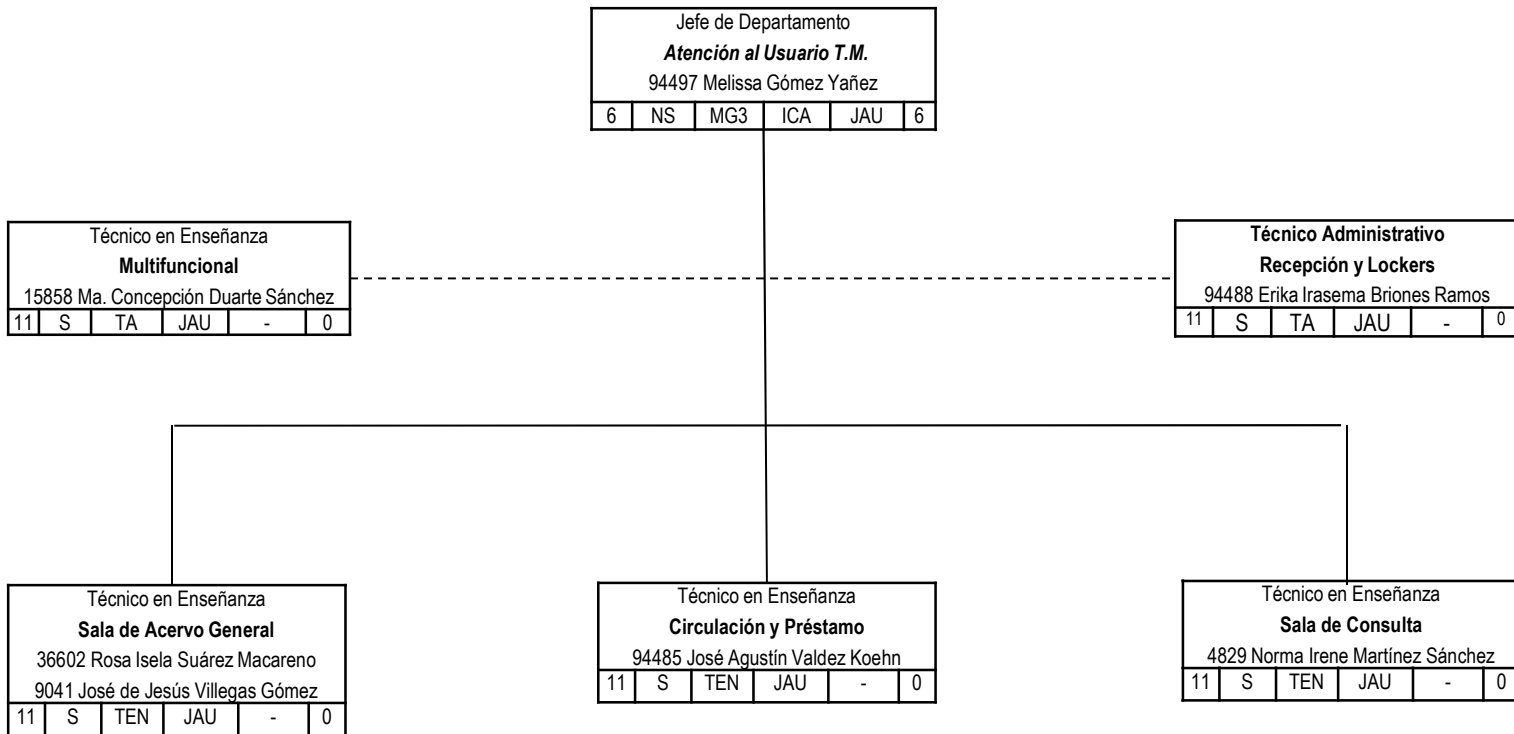



Unidad: **ADMINISTRACIÓN CENTRAL** Dependencia: **DIRECCIÓN DE ASUNTOS ACADÉMICOS**

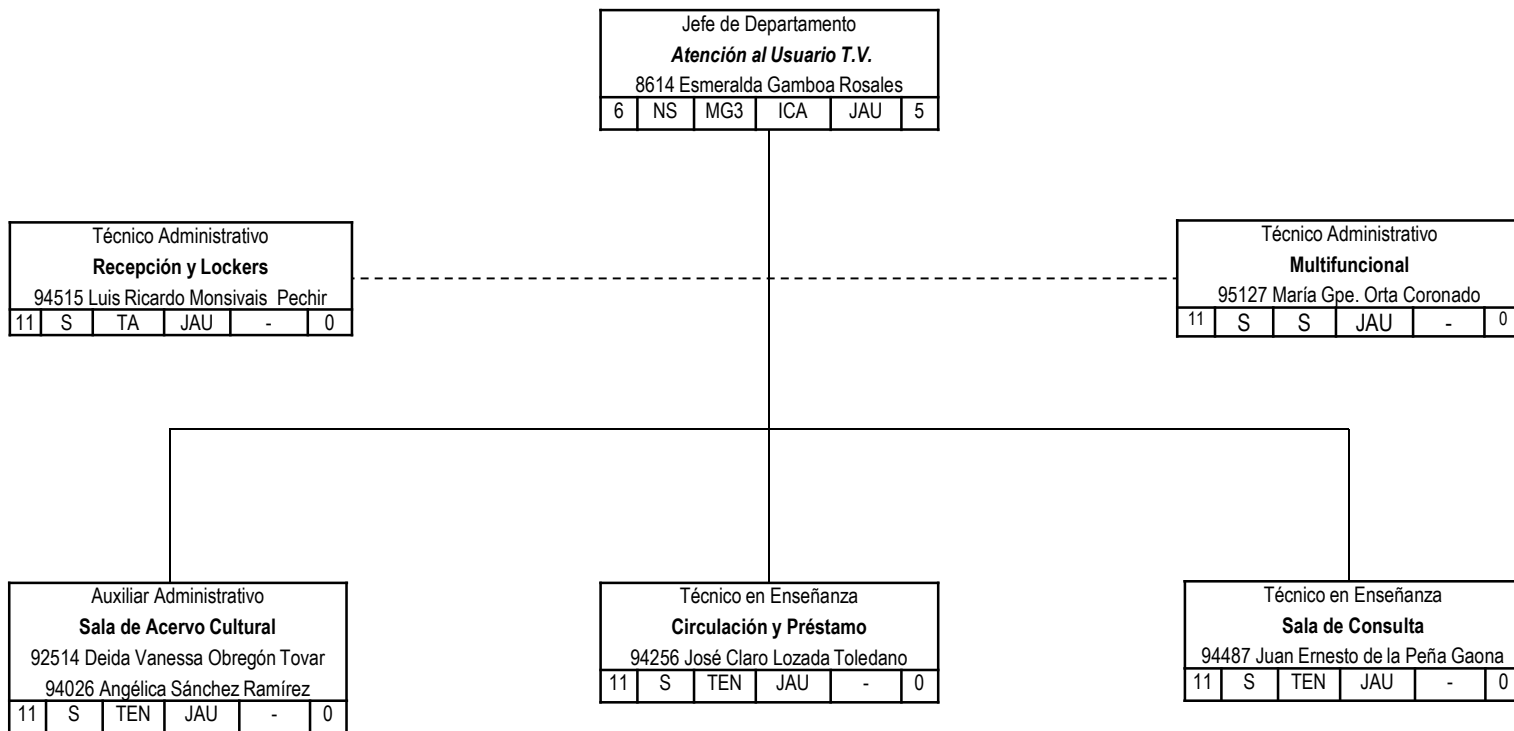



Unidad: **ADMINISTRACIÓN CENTRAL** Dependencia: **DIRECCIÓN DE ASUNTOS ACADÉMICOS**

Encargado de Sección					
<b>Biblioteca Digital / Promoción</b>					
12477 Susana Trousselle Garcés					
7	NS	MG8	ICA	BD	2

Colaborador Profesional					
<b>Auxiliar Biblioteca Digital</b>					
94498 Gerardo Govea Salas					
Turno Matutino					
91373 Jesús Antonio Hernández Obregón					
Turno Vespertino					
9	NS	CG4	BD	-	0



Unidad: **ADMINISTRACIÓN CENTRAL** Dependencia: **DIRECCIÓN DE ASUNTOS ACADÉMICOS**

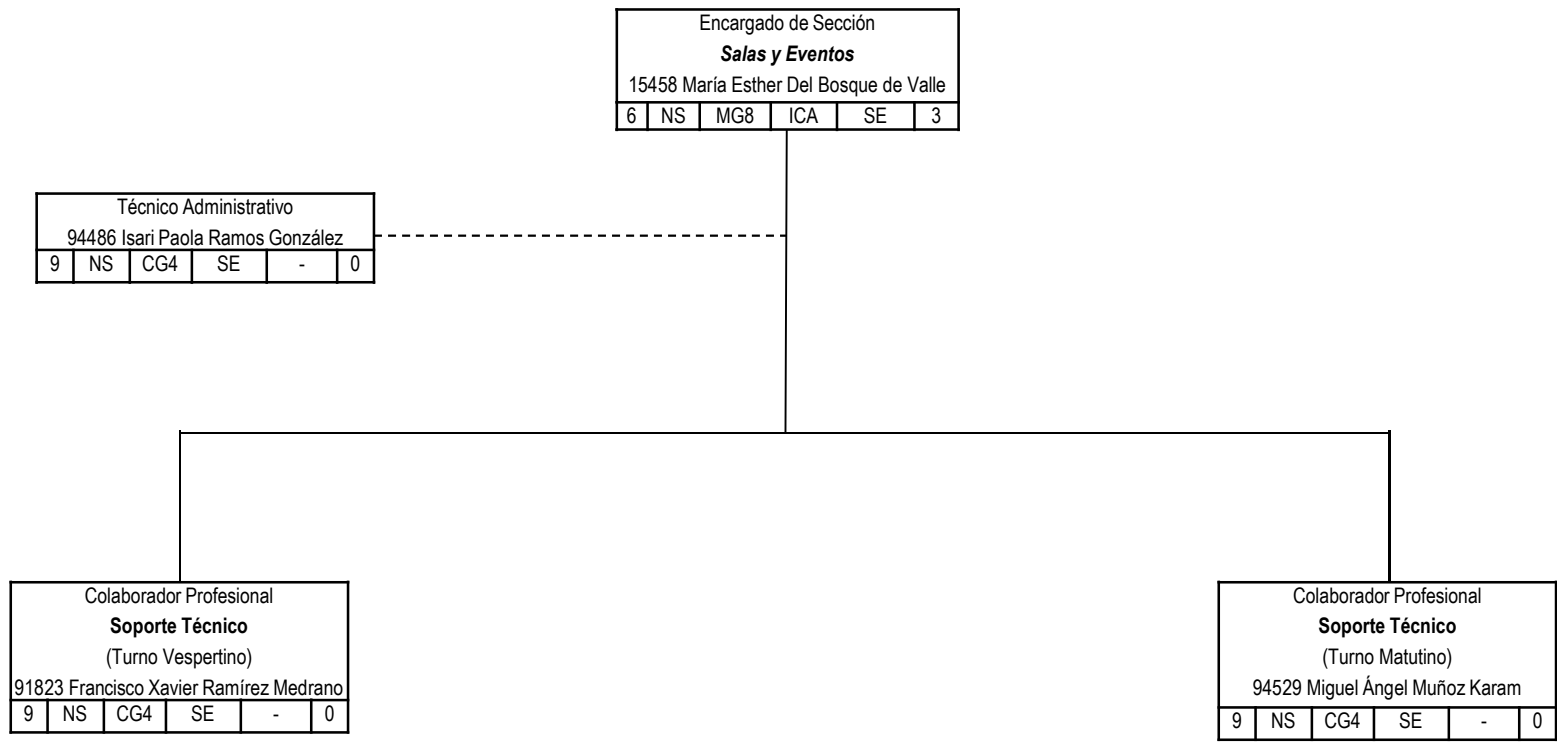



Unidad: **ADMINISTRACIÓN CENTRAL** Dependencia: **DIRECCIÓN DE ASUNTOS ACADÉMICOS**

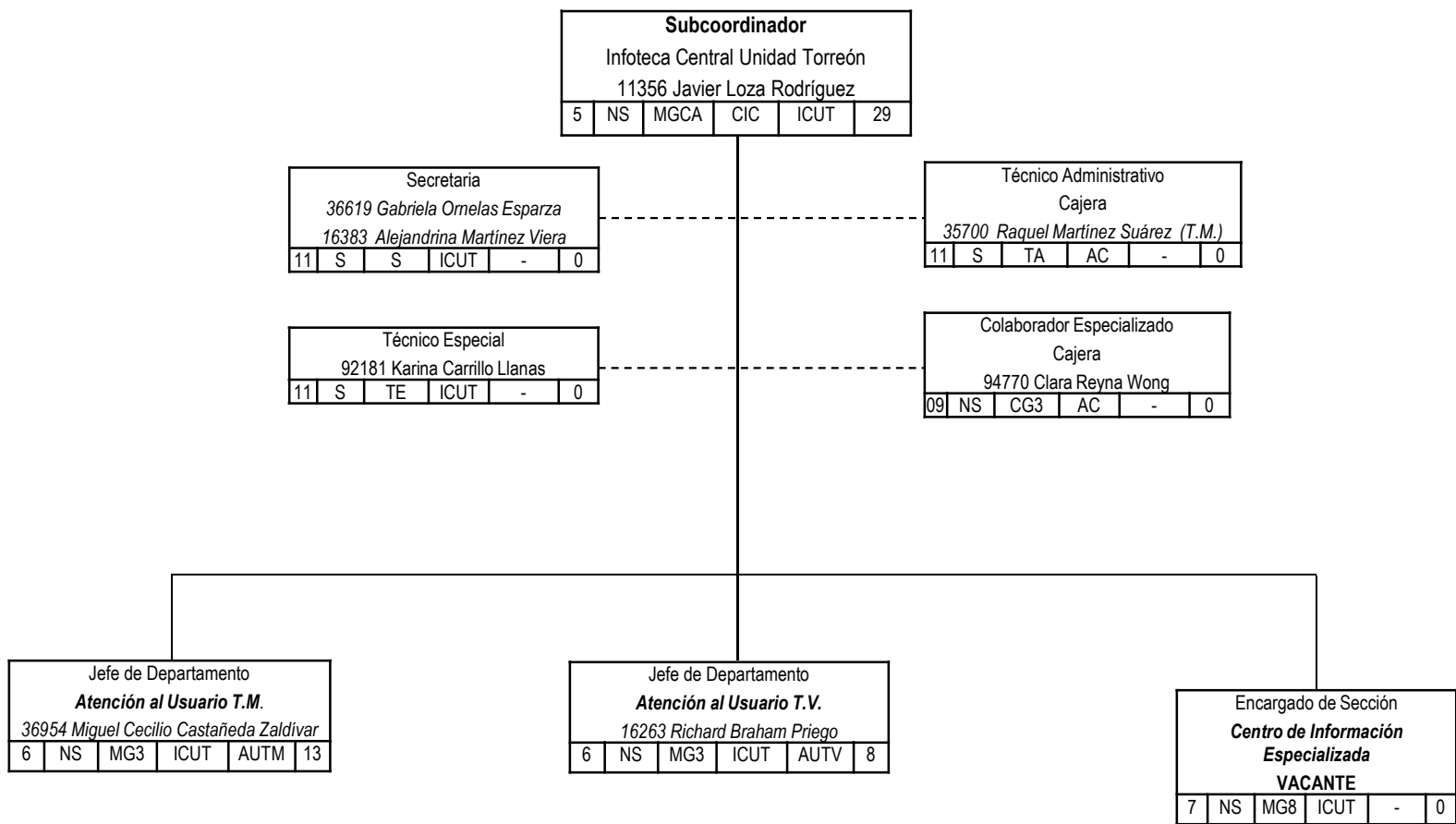



Unidad: **ADMINISTRACIÓN CENTRAL** Dependencia: **DIRECCIÓN DE ASUNTOS ACADÉMICOS**

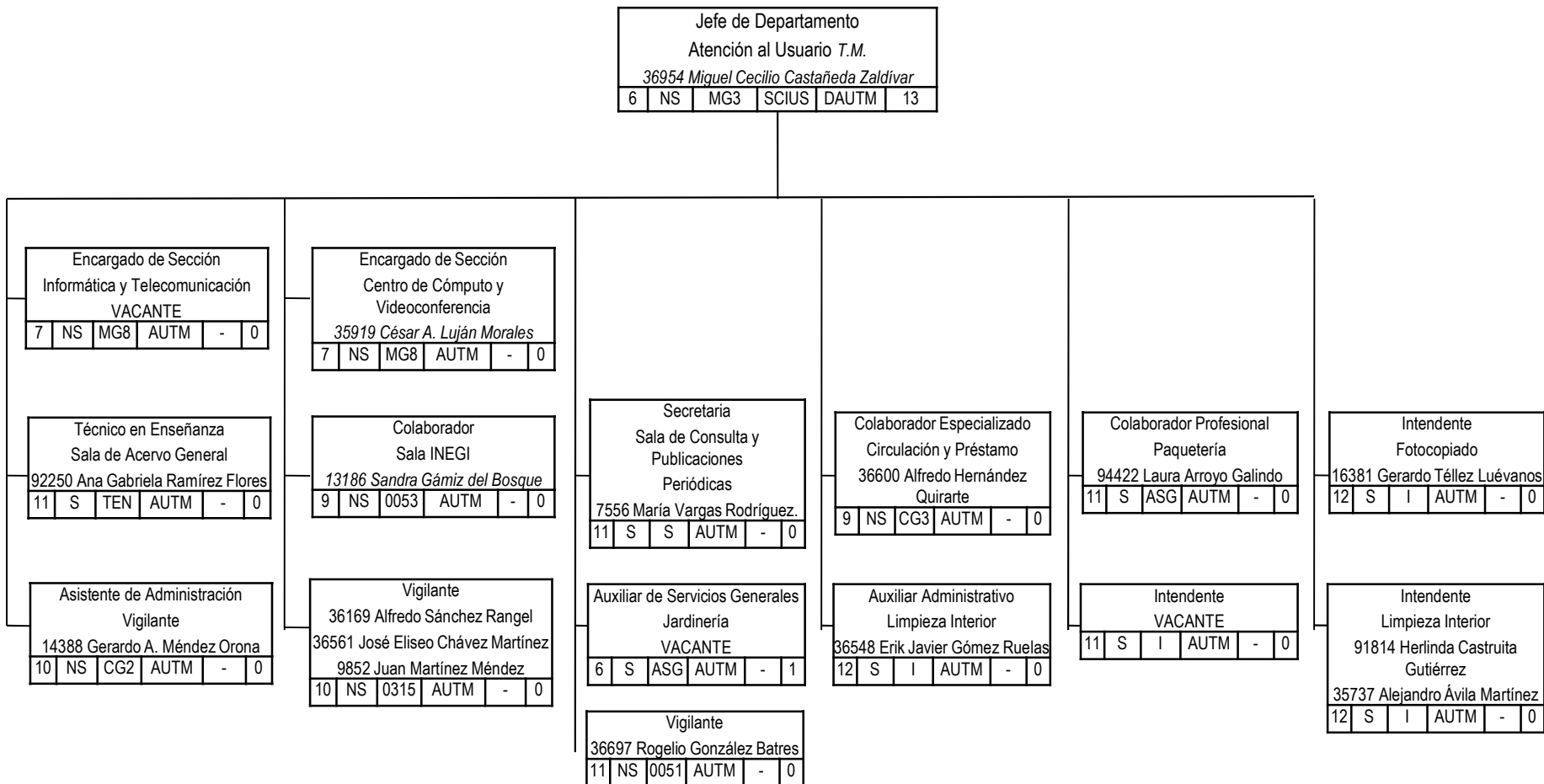



Unidad: **ADMINISTRACIÓN CENTRAL** Dependencia: **DIRECCIÓN DE ASUNTOS ACADÉMICOS**

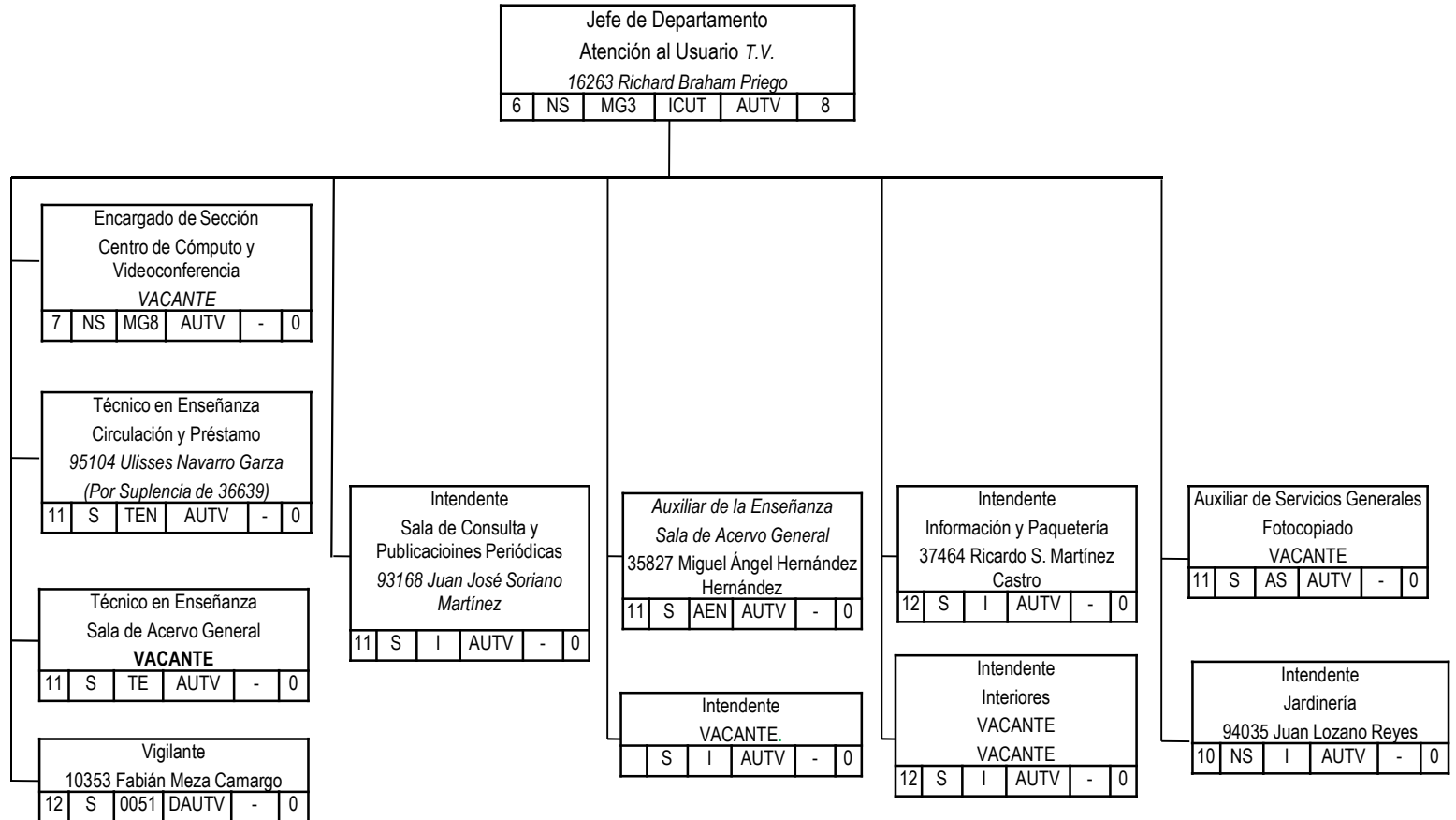



Unidad: **ADMINISTRACIÓN CENTRAL** Dependencia: **DIRECCIÓN DE ASUNTOS ACADÉMICOS**

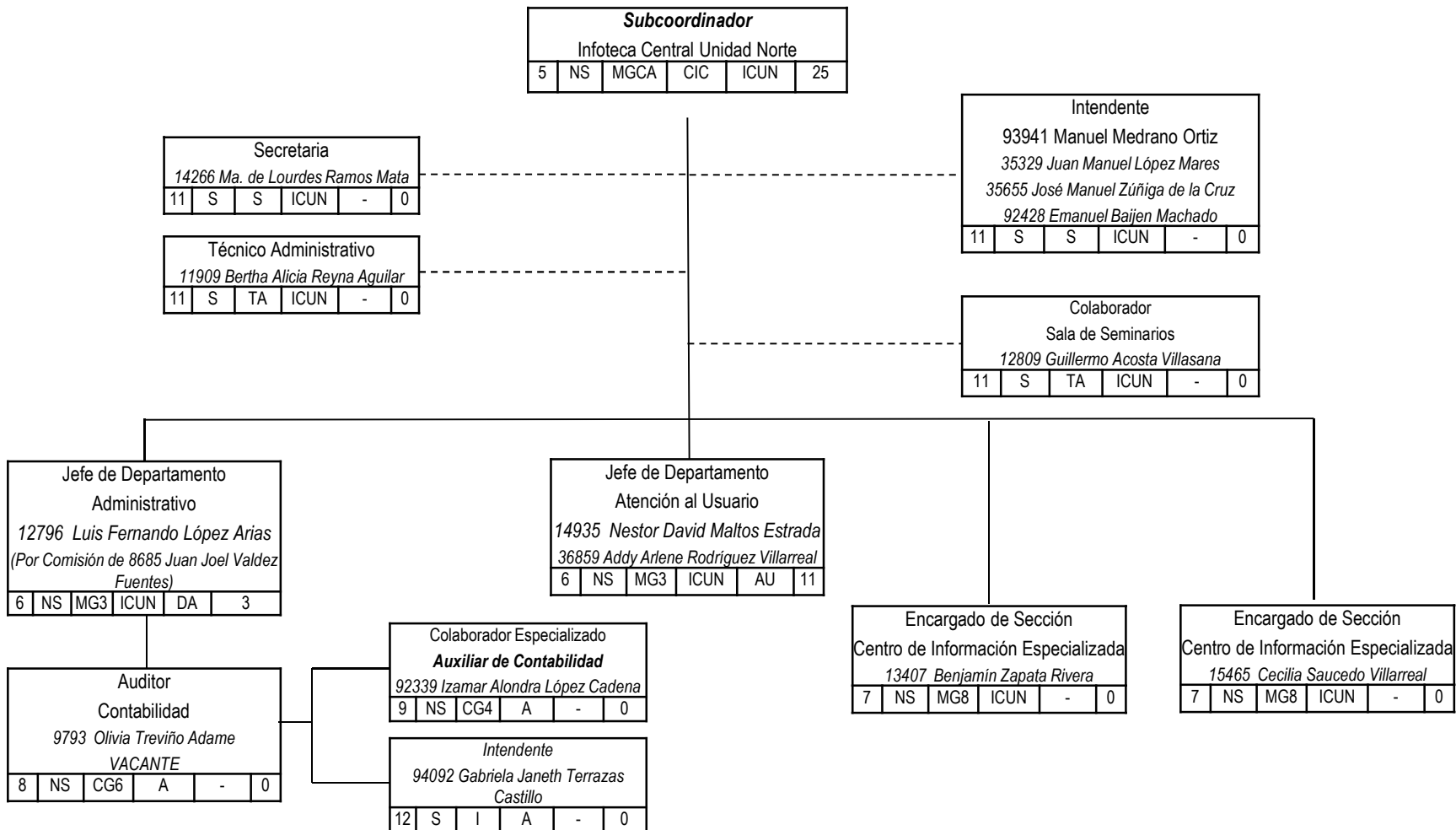





Unidad: **ADMINISTRACIÓN CENTRAL** Dependencia: **DIRECCIÓN DE ASUNTOS ACADÉMICOS**

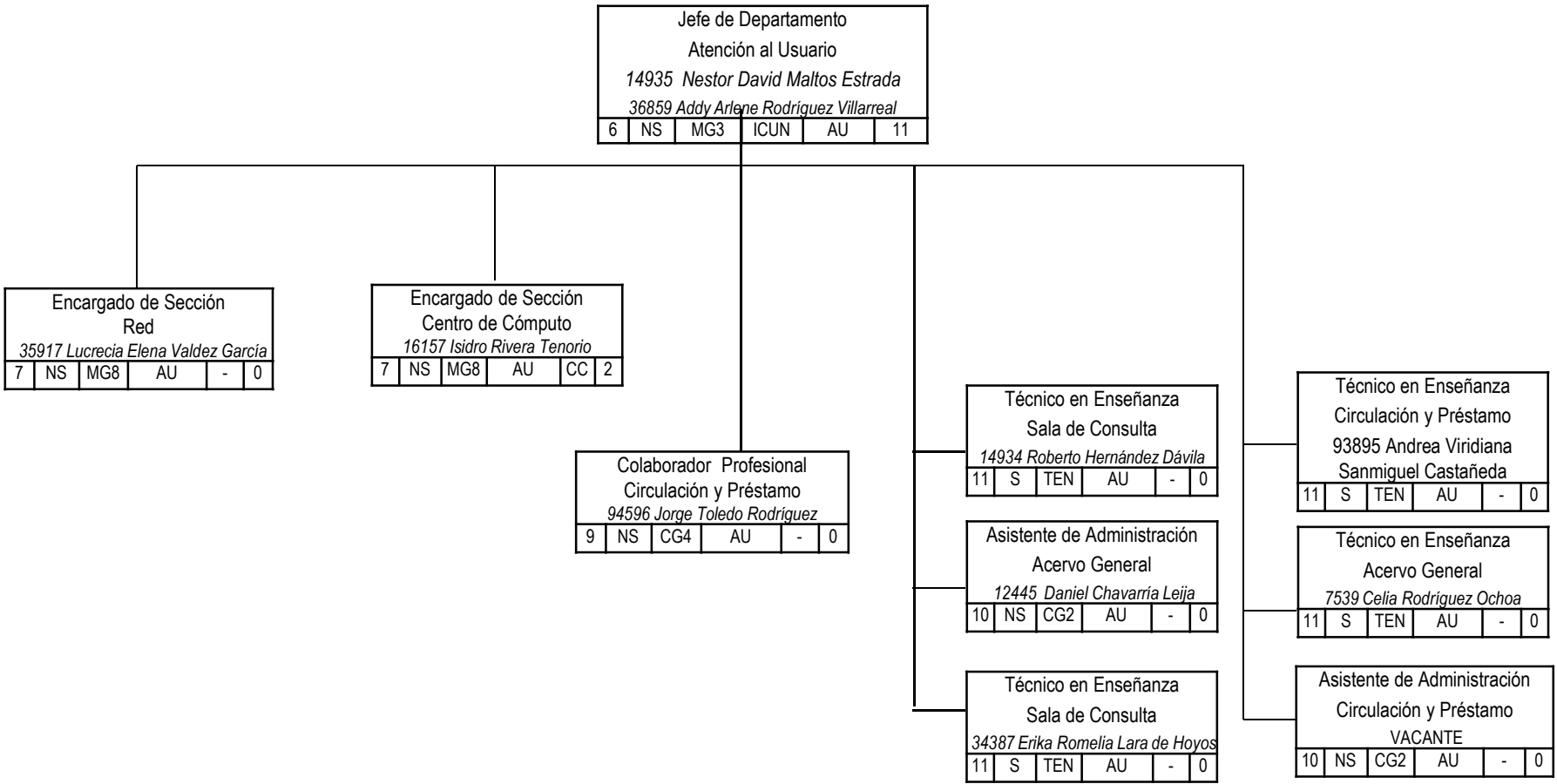



Unidad: **ADMINISTRACIÓN CENTRAL** Dependencia: **DIRECCIÓN DE ASUNTOS ACADÉMICOS**

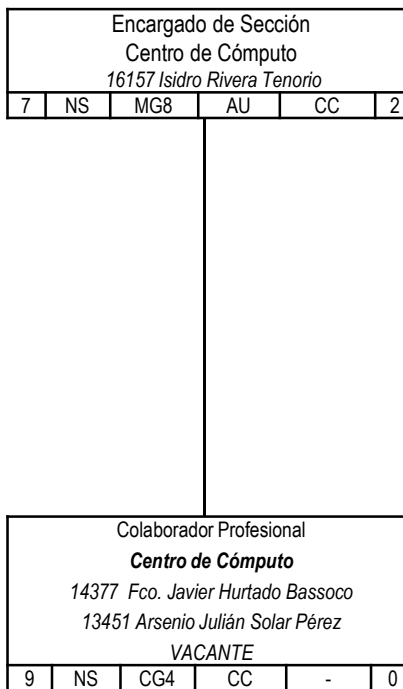



Unidad: **ADMINISTRACIÓN CENTRAL** Dependencia: **DIRECCIÓN DE ASUNTOS ACADÉMICOS**

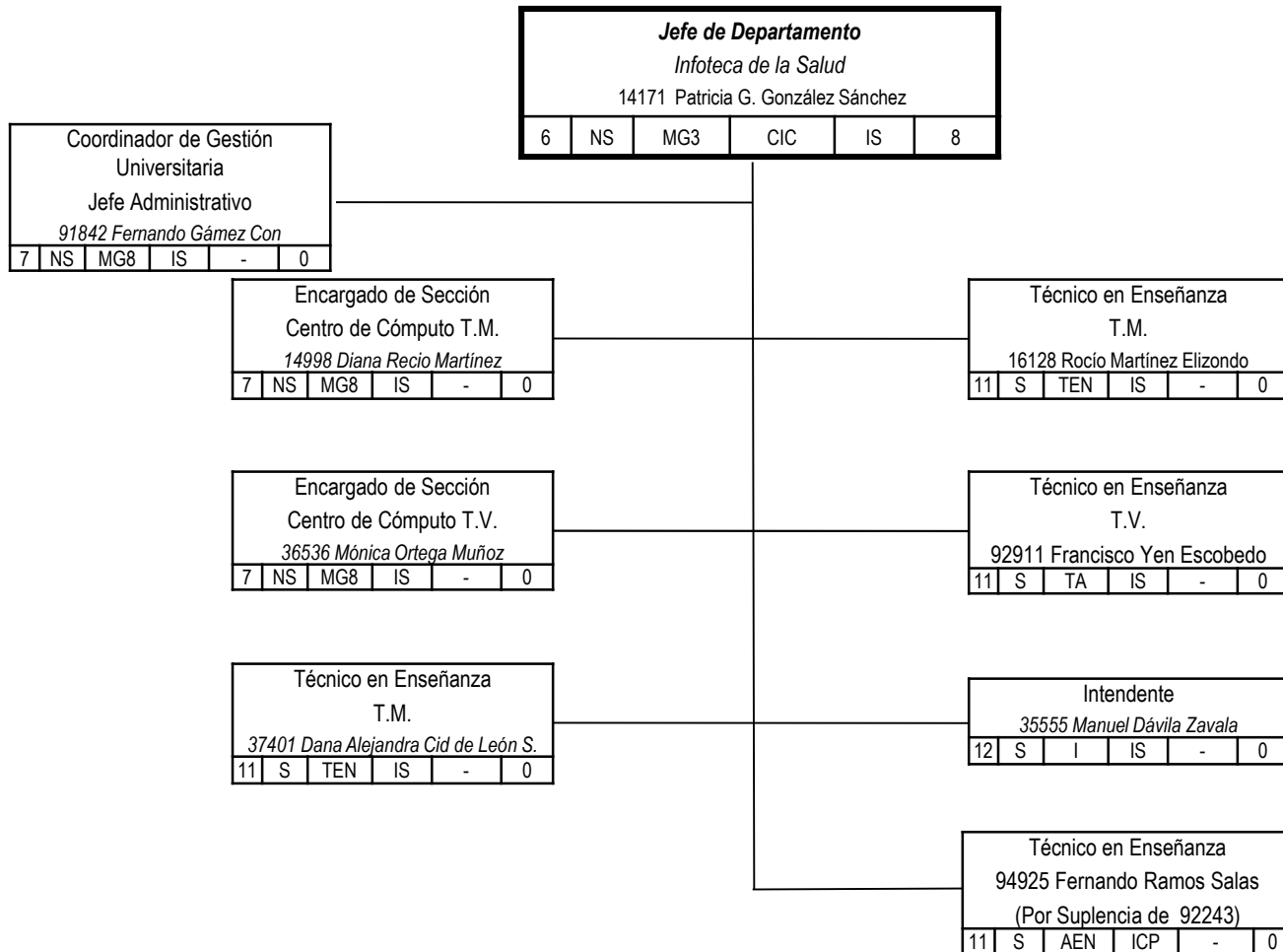



Unidad: **ADMINISTRACIÓN CENTRAL** Dependencia: **DIRECCIÓN DE ASUNTOS ACADÉMICOS**

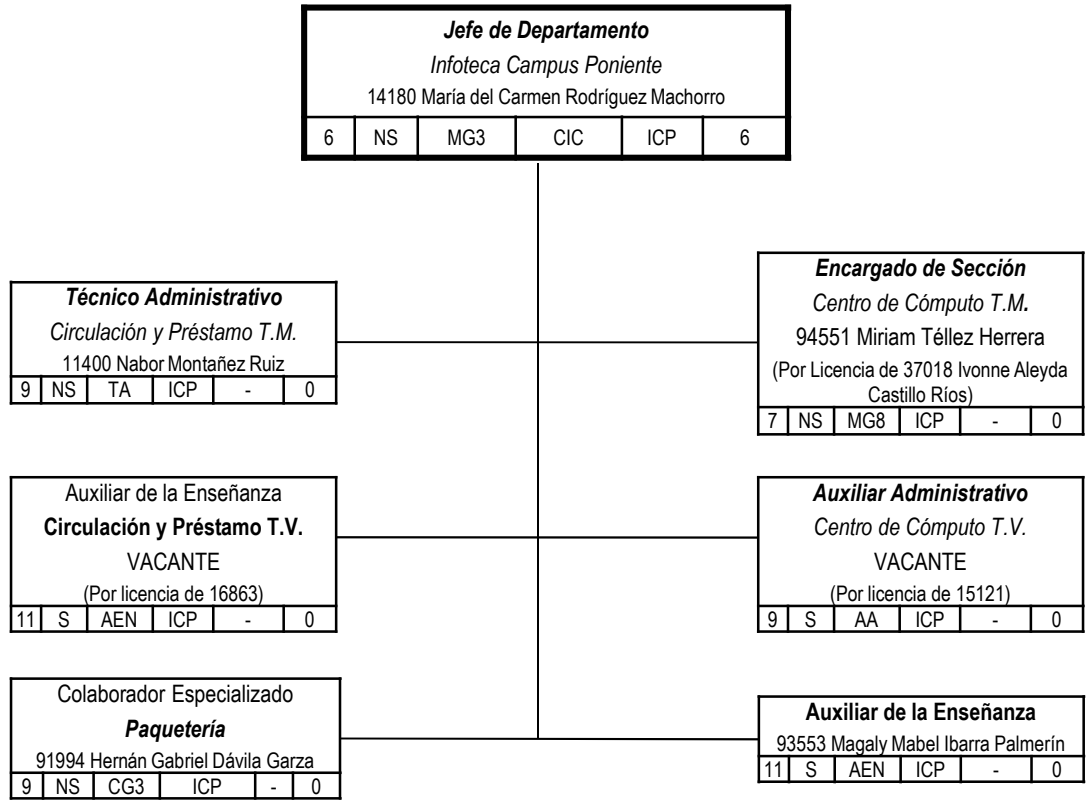



Unidad: **ADMINISTRACIÓN CENTRAL** Dependencia: **DIRECCIÓN DE ASUNTOS ACADÉMICOS**

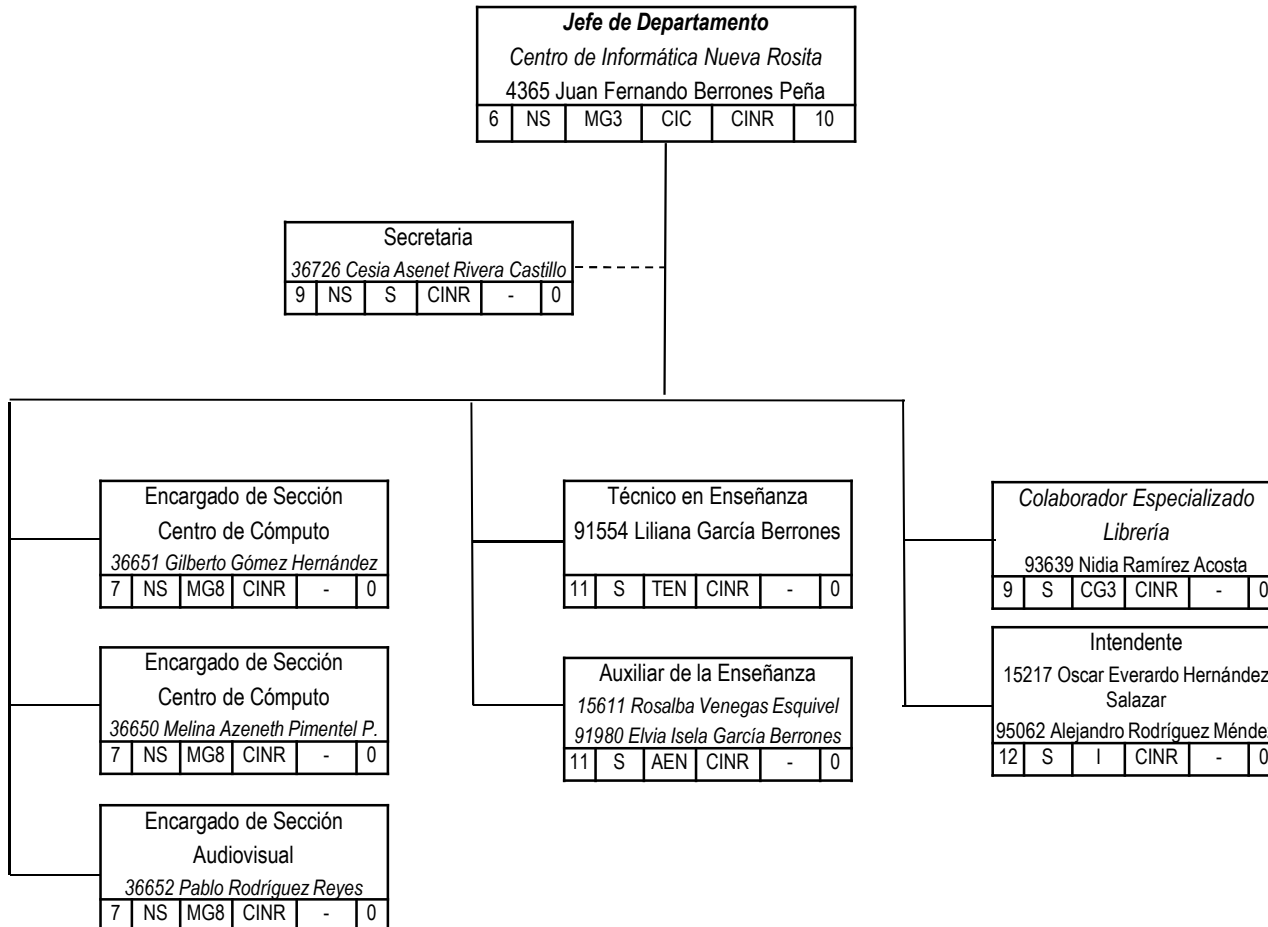



Unidad: **ADMINISTRACIÓN CENTRAL** Dependencia: **DIRECCIÓN DE ASUNTOS ACADÉMICOS**

